

UNITED STATES DISTRICT COURT  
CENTRAL DISTRICT OF ILLINOIS  
PEORIA DIVISION

UNITED STATES OF AMERICA,	)	
	)	
Plaintiff,	)	CIVIL ACTION NO. _____
	)	
v.	)	
	)	
MEYER ENTERPRISES, LLC,	)	COMPLAINT FOR
INSULATION SOLUTIONS, INC., and	)	CIVIL PENALTIES, INJUNCTION,
DONALD L. MEYER,	)	AND OTHER RELIEF
	)	
Defendants.	)	

Plaintiff, United States of America, acting upon the notification and authorization to the Attorney General by the Federal Trade Commission (“FTC” or “Commission”), for its Complaint alleges that:

1. Plaintiff brings this action under Sections 5(a)(1), 5(m)(1)(A), 13(b), 16(a), and 19 of the Federal Trade Commission Act (“FTC Act”), 15 U.S.C. §§ 45(a)(1), 45(m)(1)(A), 53(b), 56(a), and 57b to obtain: (a) monetary civil penalties, an injunction, and other relief against Defendants Meyer Enterprises, LLC; Insulation Solutions, Inc.; and Donald L. Meyer (collectively “Defendants”) for violations of the Commission’s Trade Regulation Rule Concerning the Labeling and Advertising of Home Insulation (“R-value Rule” or “Rule”), 16 C.F.R. Part 460; and (b) a permanent injunction, rescission or reformation of contracts, restitution, refund of moneys paid, disgorgement of ill-gotten gains, and other equitable relief against Defendants for engaging in deceptive acts or practices in connection with the advertising and sale of insulation products, in or affecting commerce, in violation of Section 5(a) of the FTC Act, 15 U.S.C. § 45(a).

### **JURISDICTION AND VENUE**

2. This Court has jurisdiction over this matter under 28 U.S.C. §§ 1331, 1337(a), 1345, and 1355 and under 15 U.S.C. §§ 45(m)(1)(A), 53(b), 56(a), and 57b.
3. Venue in the United States District Court for the Central District of Illinois is proper under 15 U.S.C. § 53(b) and under 28 U.S.C. §§ 1391(b) and (c) and 1395(a).

### **DEFENDANTS**

4. Defendant Meyer Enterprises, LLC (“Meyer Enterprises”) was incorporated in Illinois on March 3, 1997. Its mailing address is 401 Truck Haven Road, East Peoria, Illinois 61611. Meyer Enterprises transacts or has transacted business in this District.
5. Defendant Insulation Solutions, Inc. (“Insulation Solutions”) is wholly owned by Meyer Enterprises. Its corporate headquarters are located in Peoria, Illinois. Its mailing address is 401 Truck Haven Road, East Peoria, Illinois 61611. Insulation Solutions transacts or has transacted business in this District.
6. Defendant Donald L. Meyer (“Meyer”) is President of and has an ownership interest in Meyer Enterprises. Meyer is President of Insulation Solutions. At all times relevant to this Complaint, acting individually or in concert with others, he has formulated, directed, controlled, had authority to control, or participated in the acts or practices set forth in this Complaint. Meyer resides in East Peoria, Illinois and transacts or has transacted business in this District and throughout the United States.

### **COMMERCE**

7. At all times relevant to this Complaint, the alleged acts and practices of Defendants have been in or affecting commerce, as “commerce” is defined in Section 4 of the FTC Act, 15 U.S.C. § 44.

**DEFENDANTS' COURSE OF CONDUCT**

8. At all times material herein, Defendants have engaged in the manufacturing, advertising, labeling, offering for sale, sale, and distribution of "Insul-Tarp®" ("Insul-Tarp"), an under-slab insulation blanket with residential, commercial, and agricultural applications. Insul-Tarp consists of several layers, less than one inch thick total, including foam, bubble wrap, and an aluminum reflective material.
9. Insul-Tarp is available at a retail price of \$208.32 for a roll measuring six feet wide and fifty feet long.
10. To induce consumers to purchase Insul-Tarp, Defendants have disseminated advertisements and product labels, or have caused advertisements and product labels to be disseminated, which make claims regarding the thermal performance of Insul-Tarp, including but not limited to R-value claims. R-value is a calculation used to measure resistance to heat flow. 16 C.F.R. § 460.5.
11. Defendants' advertisements and product labels make the following claims:
  - (A) Thickness . . . ½"  
System Performance
    - R-7.54 Non-Radiant (Concrete Assembly)
    - R-10 Radiant (Field and lab supported)(Exhibit 1 - Insul-Tarp Brochure).
  - (B) Specimen/Project Description:  
Series/Model: Insul-Tarp Slab Configuration DRFB.5  
Configuration: Four inch concrete slab, ½" insulation, 2" gravel/rock, 1" sand  
Testing Conditions: . . .  
Mean plate temperature: 65.0°F nominal . . .  
Average thermal resistance (R): 7.54 hr/ft<sup>2</sup>·°F/Btu  
(Exhibit 2, page 13— Insul-Tarp Non-Radiant Catalogue).

- (C) Three tests were conducted to evaluate the effectiveness of Insul-Tarp® versus another product called Bubble-foil-bubble and also against no insulation . . . . The results of this test are shown in Figure 2. The graph shows the difference in temperature . . . .

Conclusions:

Because temperature differential has a linear relationship with heat loss, it is easy to see how the low differential temperature in 8" of limestone beneath the slab and the Insul-Tarp® helps reduce heat loss through the slab to the limestone bedding below. The bubble-foil has a temperature differential nearly twice that of Insul-Tarp® and the No insulation test has a factor of 2.5 times the differential indicating a significantly larger heat loss characteristic than that of Insul-Tarp.

(Exhibit 3, page 27 - Insul-Tarp Radiant Catalogue).

- (D) SYSTEM PERFORMANCE:  
Non-Radiant R-7.54 (Concrete Slab Assembly)  
Radiant R-10 (Field and Lab Supported)

(Exhibit 4 - Insul-Tarp Label).

- (E) When calculating heat loads for radiant heating systems, a performance equivalent of R-10 can be used. Although this is not a tested R-value, field and laboratory tests support this number as a reasonable gauge of performance.

(Exhibit 5, page 1 - excerpt from website [www.insulationsolutions.com](http://www.insulationsolutions.com)).

12. In numerous instances, Defendants have disseminated advertisements, such as Exhibit 1, which provide a thickness for Insul-Tarp but do not provide the product's R-value at that thickness.
13. In numerous instances, Defendants have disseminated advertisements, such as Exhibit 2, which provide R-values but fail to provide the thickness needed to obtain those R-values.
14. In numerous instances, Defendants have disseminated promotional materials, such as Exhibit 2, indicating that they do not base the R-7.54 claim on tests performed at 75 degrees Fahrenheit.



15. In numerous instances, Defendants have disseminated promotional materials, such as Exhibit 3, which compare Insul-Tarp to another insulation product but fail to provide R-values for Insul-Tarp and the other product at a specific thickness.
16. In numerous instances, Defendants have disseminated labels for Insul-Tarp, such as Exhibit 4, that fail to disclose the R-value of Insul-Tarp by itself and fail to provide an explanatory statement about R-values.
17. In numerous instances, Defendants have disseminated promotional materials, such as Exhibit 5, acknowledging that R-10 is not a tested R-value for Insul-Tarp.
18. Defendants have not performed any tests on Insul-Tarp by itself to determine its R-value.
19. Insul-Tarp by itself has an R-value of less than 2.
20. Insul-Tarp in conjunction with seven inches of other materials (a four inch concrete slab, two inches of gravel and/or rock, and one inch of sand) has an R-value of less than 4.

#### **SECTION 5 OF THE FTC ACT**

21. Section 5(a) of the FTC Act, 15 U.S.C. § 45(a), prohibits unfair or deceptive acts or practices in or affecting commerce. As set forth below, Defendants have engaged in unlawful practices in connection with the marketing and sale of Insul-Tarp.

#### **FALSE OR UNSUBSTANTIATED CLAIMS IN VIOLATION OF SECTION 5 OF THE FTC ACT**

##### **Count I**

22. In numerous instances, in connection with the advertising, marketing, promotion, offering for sale, sale, or distribution of Insul-Tarp, Defendants have represented, expressly or by implication, that Insul-Tarp has an R-value of 7.54.

23. The representation set forth in Paragraph 22 is false or was not substantiated at the time the representation was made. Therefore, the making of the representation set forth in Paragraph 22, above, constitutes a deceptive act or practice, in or affecting commerce, in violation of Section 5(a) of the FTC Act, 15 U.S.C. § 45(a).

#### **THE R-VALUE RULE**

24. The Commission issued the R-value Rule under Section 18 of the FTC Act, 15 U.S.C. § 57a. The Rule became effective on September 29, 1980. Since then, the Commission has issued several exemptions and stays that are not relevant to this action. The Commission amended the Rule on March 28, 1996 and on May 31, 2005, under Section 18 of the FTC Act, 15 U.S.C. § 57a, and these amendments became effective on April 29, 1996 and November 28, 2005, respectively. The Rule specifies substantiation and disclosure requirements for insulation products used in the residential market and prohibits certain claims unless they are true.
25. Section 460.5 of the R-value Rule requires that R-values given in labels, fact sheets, advertisements, and other promotional materials be based on tests conducted under the methods listed in the Rule.
26. Section 460.5(a) requires that tests on all types of insulation except aluminum foil be performed on the insulation material alone (excluding any air space) at a mean temperature of 75 degrees Fahrenheit. Section 460.5(d) requires that tests on insulation materials with foil facings be performed on the material alone, excluding any air spaces, under the methods prescribed by Section 460.5(a).

27. Section 460.12 of the R-value Rule requires manufacturers to label all packages of their insulation with the R-value of the insulation in the package and the statement: “R means resistance to heat flow. The higher the R-value, the greater the insulating power.”
28. Under Section 460.18(a) of the R-value Rule, insulation sellers that disclose the R-value of their insulation must also disclose the type of insulation and thickness needed to get that R-value.
29. Under Section 460.18(c) of the R-value Rule, insulation sellers that disclose the thickness of their insulation in advertising must also disclose the insulation’s R-value at that thickness.
30. Under Section 460.18(d) of the R-value Rule, insulation sellers that compare one type of insulation to another in advertising must also disclose the R-value at a specific thickness for each insulation.
31. Pursuant to Section 18(d)(3) of the FTC Act, 15 U.S.C. § 57a(d)(3), a violation of the R-value Rule constitutes an unfair or deceptive act or practice in violation of Section 5(a)(1) of the FTC Act, 15 U.S.C. § 45(a)(1).

## **VIOLATIONS OF THE R-VALUE RULE**

### **Count II**

32. In numerous instances, Defendants, in connection with the manufacture, distribution, promotion, and sale of home insulation, have provided, in advertising and other promotional materials, R-values for Insul-Tarp that were not based on tests conducted in the following manner:
  - (A) under American Society for Testing and Materials methods,

(B) at a mean temperature of 75 degrees Fahrenheit, and/or

(C) on the insulation material alone,

as required by Section 460.5 of the R-value Rule, thereby violating Section 460.5 of the Rule.

**Count III**

33. In numerous instances, Defendants, in connection with the manufacture, distribution, promotion, and sale of home insulation, have disseminated home insulation labels for Insul-Tarp that fail to:

(A) disclose the R-value of Insul-Tarp by itself, and/or

(B) provide an explanatory statement concerning R-values,

as required by Section 460.12 of the R-value Rule, thereby violating Section 460.12 of the Rule.

**Count IV**

34. In numerous instances, Defendants, in connection with the manufacture, distribution, promotion, and sale of home insulation, have disseminated advertising that:

(A) provides a purported R-value for Insul-Tarp without providing the thickness needed to get that R-value,

(B) provides a thickness for Insul-Tarp but without providing the product's R-value at that thickness, and/or

(C) compares Insul-Tarp to another type of insulation without giving the R-value at a specific thickness for each insulation,

as required by Section 460.18 of the R-value Rule, thereby violating Section 460.18 of the Rule.

#### **CIVIL PENALTIES**

35. Defendants have violated the provisions of the R-value Rule as described above with knowledge as set forth in Section 5(m)(1)(A) of the FTC Act, 15 U.S.C. § 45(m)(1)(A).
36. Each dissemination of an advertisement and each product label distributed by Defendants during the period June 2007 through October 2008 with an R-value Rule violation, as described in Paragraphs 32-34, above, constitutes a separate violation for purposes of computing civil penalties.

#### **CONSUMER INJURY**

37. Consumers throughout the United States have suffered and continue to suffer substantial monetary loss as a result of Defendants' unlawful acts or practices. In addition, Defendants have been unjustly enriched as a result of their unlawful acts or practices. Absent injunctive relief by this Court, Defendants are likely to continue to injure consumers, reap unjust enrichment, and harm the public interest.

#### **THIS COURT'S POWER TO GRANT RELIEF**

38. Section 5(m)(1)(A) of the FTC Act, 15 U.S.C. § 45(m)(1)(A), as modified by Section 4 of the Federal Civil Penalties Inflation Adjustment Act of 1990, 28 U.S.C. § 2461, as amended, and as implemented by 16 C.F.R. § 1.98(d), authorizes this Court to award monetary civil penalties of not more than \$11,000 for each violation of the R-value Rule.
39. Section 13(b) of the FTC Act, 15 U.S.C. § 53(b), empowers this Court to grant injunctive and other ancillary relief, including but not limited to rescission or reformation of

contracts, restitution, the refund of moneys paid, and the disgorgement of ill-gotten gains by Defendants, to prevent and remedy any violations of any provision of law enforced by the FTC.

40. Section 19 of the FTC Act, 15 U.S.C. § 57b, authorizes the Court to award such relief as is necessary to redress the injury to consumers or others resulting from Defendants' violations of the R-value Rule.

#### **PRAYER FOR RELIEF**

WHEREFORE, the FTC, pursuant to Sections 5(a), 5(m)(1)(A), 13(b), and 19 of the FTC Act, 15 U.S.C. §§ 45(a), 45(m)(1)(A), 53(b), and 57b, and the Court's own equitable powers, requests that the Court:

- (A) Enter a permanent injunction to prevent future violations of the FTC Act and the R-value Rule by Defendants;
- (B) Award Plaintiff monetary civil penalties from Defendants for each violation of the R-value Rule;
- (C) Award such relief as the Court finds necessary to redress injury to consumers resulting from Defendants' violations of the FTC Act and the R-value Rule, including but not limited to, rescission or reformation of contracts, restitution, the refund of monies paid, and the disgorgement of ill-gotten monies; and
- (D) Award Plaintiff the costs of bringing this action, as well as such other and additional relief as the Court may determine to be just and proper.

Dated:

OF COUNSEL:

JAMES A. KOHM  
Associate Director for Enforcement

ROBERT M. FRISBY  
Assistant Director for Enforcement

MELINDA A. CLAYBAUGH  
Attorney

MALINI MITHAL  
Attorney

Federal Trade Commission  
Division of Enforcement  
601 New Jersey Avenue, N.W.  
Suite NJ-2122  
Washington, D.C. 20001  
Telephone: 202-326-2203 (Claybaugh)  
202-326-2972 (Mithal)  
Fax: 202-326-2558  
E-mail: mclaybaugh@ftc.gov (Claybaugh)  
mmithal1@ftc.gov (Mithal)

**FOR THE PLAINTIFF  
UNITED STATES OF AMERICA:**

MICHAEL F. HERTZ  
Acting Assistant Attorney General  
Civil Division  
United States Department of Justice

RODGER A. HEATON  
United States Attorney  
Central District of Illinois

**s/: Gerard A. Brost**  
GERARD BROST  
Assistant United States Attorney  
One Technology Plaza  
211 Fulton Street, Suite 400  
Peoria, IL 61602  
309-671-7050  
309-671-7259  
[Gerard.Brost@usdoj.gov](mailto:Gerard.Brost@usdoj.gov)

EUGENE M. THIROLF  
Director  
Office of Consumer Litigation

KENNETH L. JOST  
Deputy Director  
Office of Consumer Litigation

**s/: Daniel K. Crane-Hirsch**  
DANIEL K. CRANE-HIRSCH  
Trial Attorney  
Office of Consumer Litigation  
U.S. Department of Justice  
PO Box 386  
Washington, D.C. 20044  
202-616-8242  
202-514-8742  
[Daniel.Crane-Hirsch@usdoj.gov](mailto:Daniel.Crane-Hirsch@usdoj.gov)

# EXHIBIT 1



# INSUL-TARP®

## • TRULY EFFICIENT

Improves the performance of the heating system and provides higher slab temperature output.

## • EASY TO INSTALL

Lightweight, minimal seaming, rolled into place.

## • GREATER PROFITS

Priced competitively with other insulation materials and can be installed in a fraction of the time.

## • CONSISTENT PERFORMANCE

Material is not affected by moisture or humidity, allowing high R-values to remain consistent over time.

## • THE RIGHT CHOICE

Insul-Tarp's reflective insulation technology leaves all other insulation practices out in the cold. When you install Insul-Tarp, you can rest assured that you are using the best product available for under-slab insulation.

### TECHNICAL DATA

Thickness: ..... 1/2"  
System Performance  
• R-7.54 Non-Radiant (Concrete Assembly)  
• R-10 Radiant (Field and lab supported)

Weight per 150 sq. ft. .... 2.5 lbs.

Bursting Strength ..... 90 PSI

Fire Rating: ..... Up to Class A-1

Temp. Range: ..... 60°F - 180°F

Reflectivity: ..... Up to 97%

Permeance Rate: ..... 0.002

Shrinkage: ..... None

Puncture, Tear, Impact and Snag Resistant as well as Mildew and Fungi Resistant

*Note: Roll size is approximate. Please estimate 10% overage to ensure adequate amount of product. Detailed technical data available upon request.*

# INSUL-TARP®

Distributed by:

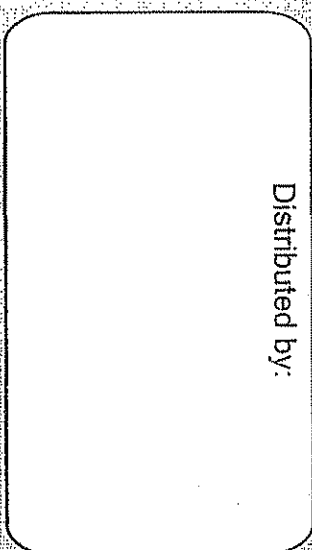

[www.insulationsolutions.com](http://www.insulationsolutions.com)

# INSUL-TARP®

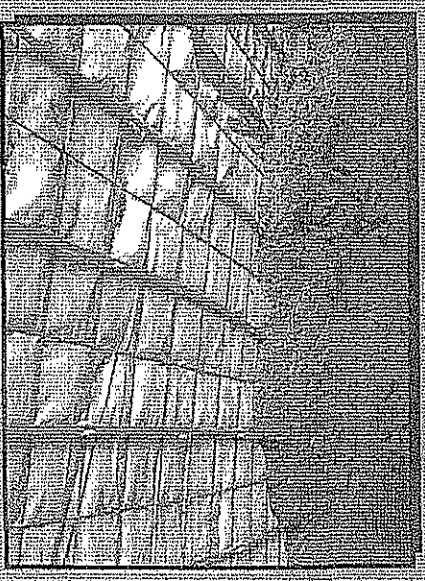

## UNDER-SLAB INSULATION

RESIDENTIAL  
COMMERCIAL  
AGRICULTURAL



## WHAT IS INSUL-TARP?

**Insul-Tarp** is a patented revolutionary product like no other on the market today. Its lightweight, Space Age design integrates closed cell foam and an aluminum reflective material with a protective poly coating all within three thin layers.

The durable poly coating protects the insulating material from potentially damaging surfaces and is impermeable to moisture, helping it to maintain a high R-value in a minimal amount of space.

The superior physical characteristics and overall design of **Insul-Tarp** make it the most effective product for insulating under concrete slabs in Residential, Commercial and Agricultural radiant systems.

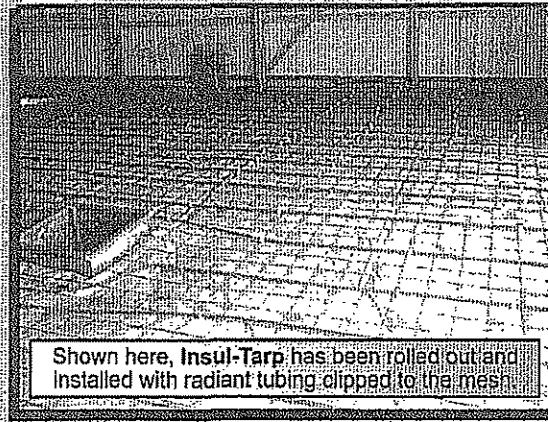
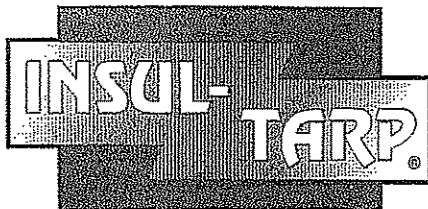
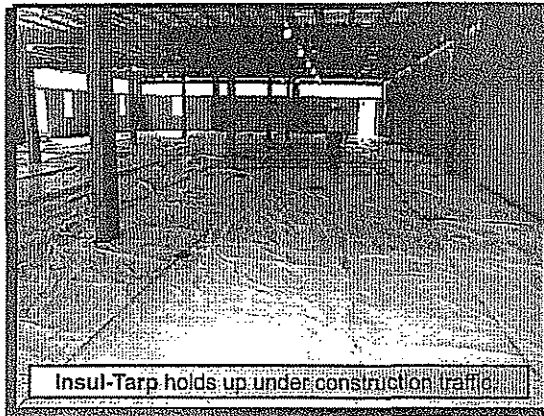

## WHY IS INSUL-TARP SO REVOLUTIONARY?

**Insul-Tarp's** innovative combination of layers and reflective material enable it to effectively control all three modes of heat transfer -- Conduction, Convection and Radiation.

Traditional mass insulation, such as foam board, mainly addresses conduction and convection and has been shown to be only 30% effective with dealing with radiant heat flow.

**Insul-Tarp** reduces the downward heat loss of the radiant heating system by redirecting it back into the living area. There is no need to use other insulating products in conjunction with **Insul-Tarp** for it to achieve its superior performance. **Insul-Tarp** stands alone!

[www.InsulationSolutions.com](http://www.InsulationSolutions.com)

## HOW WILL INSUL-TARP REVOLUTIONIZE YOUR BUSINESS?

### Easy to Handle:

Lightweight **Insul-Tarp** rolls are available in 6'x25', 6'x50', 12'x25' and 12'x50'. **Insul-Tarp** can be carried and installed by one person.

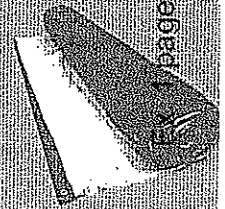

### Quick Installation:

**Insul-Tarp** can take less than 1/4 the time of conventional insulation to install. While rigid insulation requires the subsoil surface to be lowered and leveled, no special preparations are needed to accommodate **Insul-Tarp**. Installation around plumbing is almost effortless. Simply cut an 'X' in the tarp and slide it over the top of the pipe. **Insul-Tarp** means less time, less mess and less effort.

### Quicker Response Time:

With **Insul-Tarp's** under-slab installation, the response time of the heating system is quicker and more consistent due to the insulation's superior properties. **Insul-Tarp** significantly decreases the heat loss to the earth below the slab, allowing the system to react more efficiently and accurately to a shift in temperature. A quicker response time means a happier customer.

### Effective Vapor and Radon Barrier:

**Insul-Tarp's** low perm rate allows it to act as a vapor barrier. Therefore, it becomes very effective in preventing gas infiltration, creating a safer living environment.

## **EXHIBIT 2**



**INSUL-  
TARP®**

**NON-RADIANT**

**Your Answer for Under-Slab Insulation**

**Residential**

**Commercial**

**Agricultural**

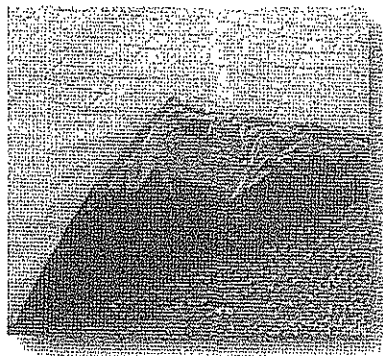

Insulation Solutions, Inc.  
An Affiliate of Meyer Enterprises, LLC  
401 Truck Haven Road  
East Peoria Illinois 61611  
Toll Free: 866.698.6562  
Ph: 309.698.0062  
Fax: 309.698.0065  
[www.insulationsolutions.com](http://www.insulationsolutions.com)



**InsulationSolutions®**



# INSUL-TARP®

## Table of Contents



<b>PRODUCT INFORMATION.....</b>	<b>1</b>
<b>ADVANTAGES.....</b>	<b>2</b>
<b>BUILDING TRADE ADVANTAGES.....</b>	<b>3</b>
<b>INSTALLATION INSTRUCTIONS.....</b>	<b>4</b>
<b>INSTALLATION DRAWINGS.....</b>	<b>5</b>
<b>ASTM E 1643.....</b>	<b>7</b>
<b>MSDS.....</b>	<b>9</b>
<b>TEST DATA SHEET.....</b>	<b>11</b>
<b>ON-SITE PHOTOS.....</b>	<b>12</b>
<b>NOTES.....</b>	<b>14</b>



# What is INSUL-TARP®?



**Insul-Tarp®** is a patented revolutionary product like no other on the market today. Its lightweight, Space Age design integrates closed cell foam and an aluminum reflective material with a protective poly coating, all within three thin layers. The durable poly coating protects the insulation material from potentially damaging surfaces and is impermeable to moisture, helping it to maintain a high R-Value in a minimal amount of space. The superior physical characteristics and overall design of **Insul-Tarp®** make it the most effective product for insulating under concrete slabs in residential, commercial, and agricultural applications.



**Insul-Tarp®**'s innovative combination of layers and reflective material enable it to effectively control all three modes of heat transfer: Conduction, Convection, and Radiation.

**Insul-Tarp®** insulation was designed specifically for under-slab applications. **Insul-Tarp®** provides excellent thermal performance and a vapor-barrier, all in one easy to use product.

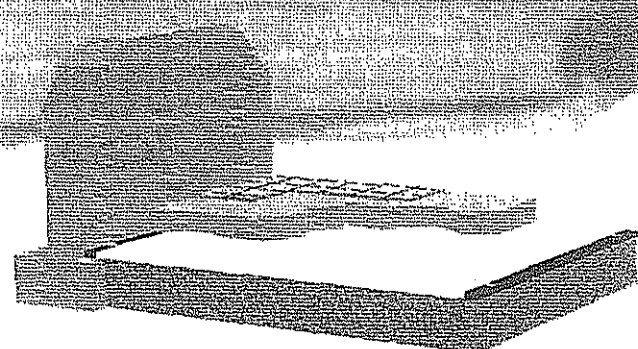

**Insul-Tarp®**

- **Easy to Install**  
Lightweight, minimal seaming, rolled into place
- **Greater Profits**  
Competitively priced  
Installed in a fraction of the time
- **Consistent Performance**  
Not affected by moisture or humidity  
R-Values remain consistent over time
- **The Right Choice**  
**Insul-Tarp®**'s reflective insulation technology leaves all other insulation practices out in the cold. When you install **Insul-Tarp®**, you can rest assured that you are using the best product available for your under-slab insulation needs.

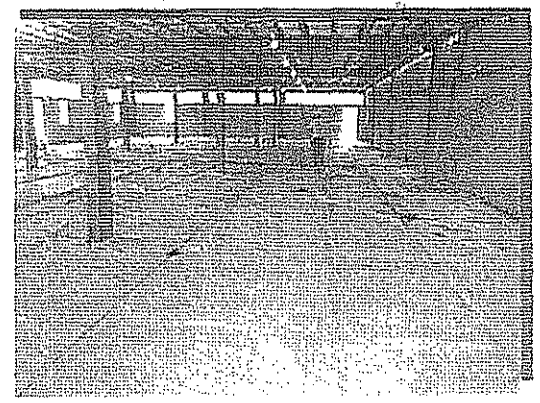

**Insul-Tarp® Roll Sizes:**

- \*\*12' X 50' = 50lbs.      6' X 50' = 25lbs.
- \*\*12' X 25' = 25lbs.      6' X 25' = 12lbs.

\*\*12' rolls consist of (2) 6' rolls seamed together.  
Widths on these rolls may vary.

Note: On any roll size, always estimate 10% extra to ensure you order enough for proper coverage.





# INSUL-TARP®

## Advantages

### Insul-Tarp Advantages Over Foam Board

<b>Insul-Tarp</b>	<b>Foam Board</b>
Lightweight & Easy to Carry.....	Requires Careful Handling
Easily Stored on Job Site.....	Should be Secured on Job Site
Minimal Excavation.....	Additional Excavation
Conforms to Subsoil.....	Requires Level Subsoil
Extremely Durable.....	Fragile & Easily Damaged
150-600 sq. ft. Rolls.....	32 sq. ft. Maximum
Quicker Installation.....	Install One Board at a Time
Easy to Cut & Modify with Scissors/Utility Knife.....	Requires Special Cutting Tools
Grommets in the Side Flanges.....	No Grommets
Less Seams = Minimal Taping.....	More Seams = Added Taping
Effective Vapor Barrier.....	Secondary Barrier Needed
Effective Radon Barrier.....	Secondary Barrier Needed
Reflects Radiant Heat Transfer.....	Absorbs Radiant Heat Transfer

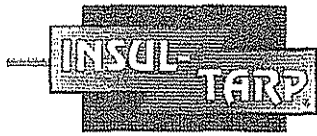

# INSUL-TARP®

## Advantages for the Building Trade

### ASTM C518 TESTING

At 20 $\Delta$ T, Insul-Tarp tested at (R) 7.54 hr·ft<sup>2</sup>·°F/Btu.  
At 15 $\Delta$ T, Insul-Tarp tested at (R) 7.79 hr·ft<sup>2</sup>·°F/Btu.

### ASTM E96 TESTING

Insul-Tarp tested out at a .002 perm rating for moisture vapor transmission. Any material with a perm rating of less than one is considered a moisture retarder.

### ASTM D751-00 TESTING (Bursting Strength)

Insul-Tarp has a 90 psi bursting strength on the bubble layer within the tarp.

### ASTM D412-98 TESTING (Tensile Strength)

Insul-Tarp tested out to have a tensile strength of 136 psi.

### ASTM D3575-00 TESTING (Compression Set)

Specimen Size: 2" x 2" x 1"  
Temperature: 23°C @ 50% R.H.  
Compression: 50%  
Test: 2 hours  
Recovery: 24 hours  
Compression Percentage Result: 4.3%

### COMPRESSION STRENGTH

Less than 10% compression at 136 lbs. per square inch when compared to rigid insulation, which is 25 lbs. per square inch. A typical 4" slab is less than one pound per square inch.

### SOIL-GAS RETARDER

Insul-Tarp consists of a polyethylene structure that is required by code to retard the flow of soil gases into the building.

### TERMITE INFESTATION

With durable outer skins and aluminum within, Insul-Tarp will act as a barrier to termites.

### DURABILITY

Insul-Tarp can withstand rigorous foot traffic, which is a common occurrence in concrete slab applications.





# INSUL-TARP®

## Installation Instructions

**Insul-Tarp® has been designed to be installed quickly and easily by following a few easy steps.**

- 1) **Insul-Tarp®** comes to the customer in roll form. Simply cut the retaining tape with a utility knife or scissors and unfold the tarp.
- 2) Install **Insul-Tarp®** with the white side facing up.
- 3) Adjust the tarp to where it is square and install the next tarp. The tarps should be overlapped at the seams. Make sure that you have insulation to insulation. For a continuous vapor barrier, seams should be taped using an appropriate tape product.
- 4) When coming to an obstruction such as plumbing, simply put the tarp up to the obstruction, with scissors or a sharp utility knife, cut an "X" in the tarp. Slide the tarp over the obstruction and continue. When cutting the tarp to size, use scissors.
- 5) **Insul-Tarp®** is manufactured with grommets in the side flanges. These grommets can be used to tie down the tarps in windy conditions.
- 6) If air pockets occur, when pouring the concrete slab, simply cut a slit in the top layer of the tarp to release any trapped air. Then place a piece of appropriate tape over the slit and continue pouring.

### Helpful Hints

- When cutting **Insul-Tarp®** always use scissors and install the cut edge under the factory edge. If factory edge is not available, simply tape the edge of the tarp.
- When installing **Insul-Tarp®** on a sunny day, make sure to wear a pair of sunglasses as **Insul-Tarp®** will reflect the sun's rays.
- When ordering square footage for a project, add **10%** for overlap and seamed edges. **Insul-Tarp®** is designed with a 2" vapor seam around the tarp. This overlap provides for an effective vapor/moisture barrier. **Note:** Actual size of **Insul-Tarp®** may slightly vary in length and width.

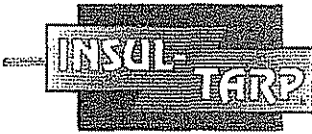

# INSUL-TARP®

## Installation Drawings

**Floating Slab on Grade with Exterior Perimeter Insulation**

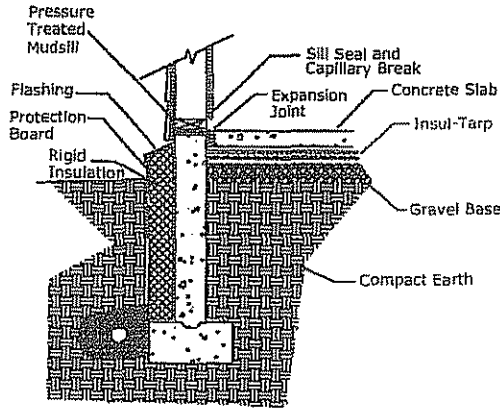

**Monolithic Slab on Grade with Exterior Perimeter Insulation**

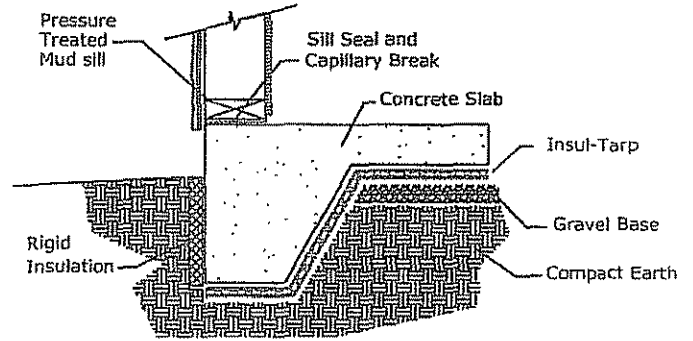

**Thermal Break Between Slabs of Heated and Unheated Floor Spaces**

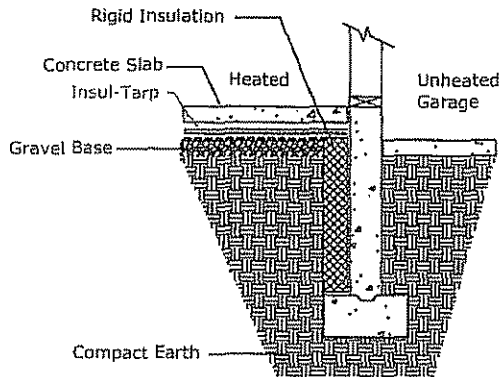

**Thermal Break Between Slabs of Heated and Unheated Floor Spaces**

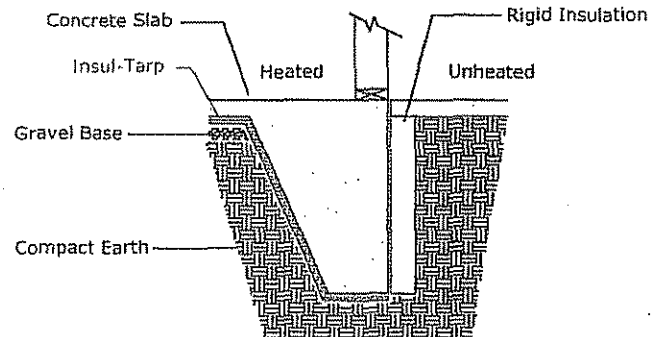

**Thermal Break Between Slabs of Heated and Unheated Floor Spaces**

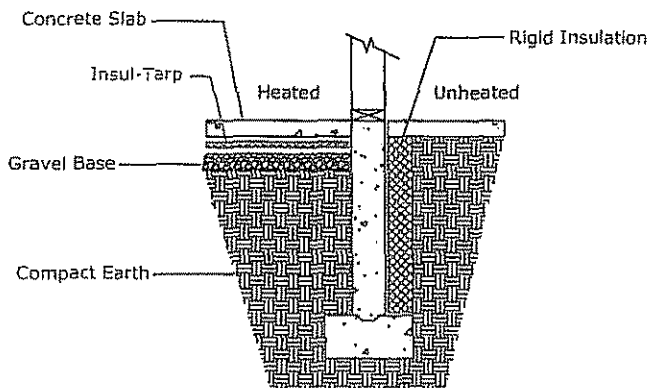

**Thermal Break Between Heated Space Slabs and Unheated Crawl Space**

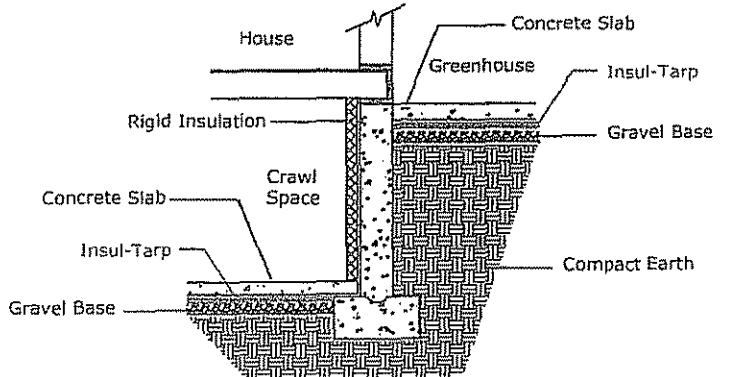

# INSUL-TARP®

## Installation Drawings

### Insul-Tarp Cut and Taped Around I-Beam

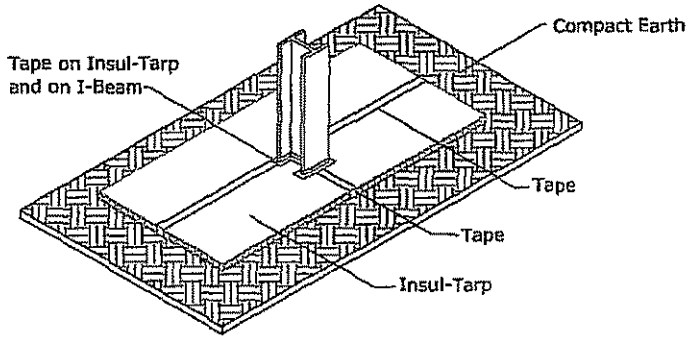

### Insul-Tarp Cut and Taped Around Pipe

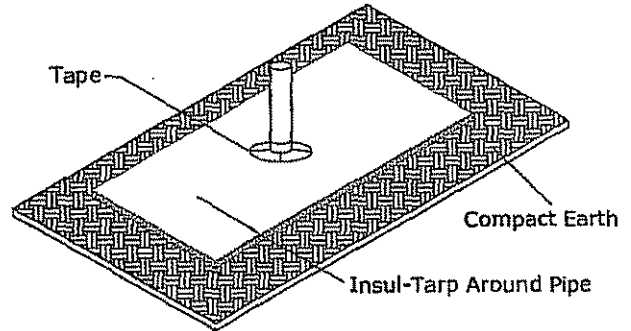

### Depressed Footing Detail 1

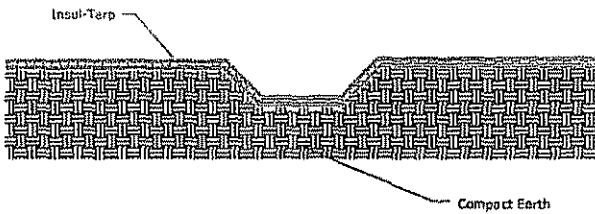

### Depressed Footing Detail 2

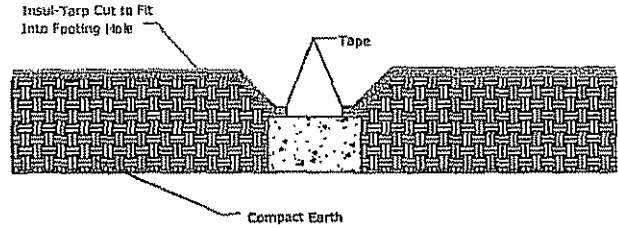

### Foundation Wall Taping Detail

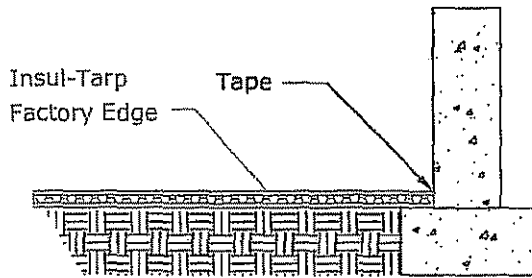

### Overlap Taping Details

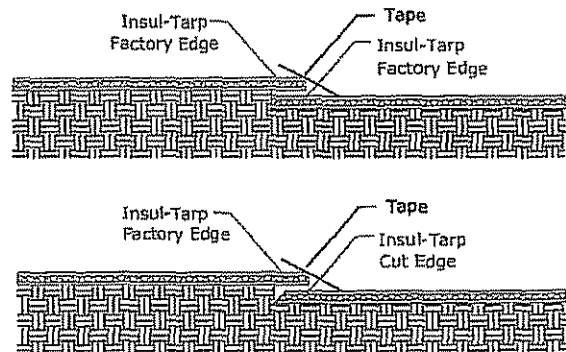



Designation: E 1643 – 98

AMERICAN SOCIETY FOR TESTING AND MATERIALS  
100 Barr Harbor Dr., West Conshohocken, PA 19428  
Reprinted from the Annual Book of ASTM Standards. Copyright ASTM

## Standard Practice for Installation of Water Vapor Retarders Used in Contact with Earth or Granular Fill Under Concrete Slabs<sup>1</sup>

This standard is issued under the fixed designation E 1643; the number immediately following the designation indicates the year of original adoption or, in the case of revision, the year of last revision. A number in parentheses indicates the year of last reapproval. A superscript epsilon ( $\epsilon$ ) indicates an editorial change since the last revision or reapproval.

### 1. Scope

1.1 This practice covers procedures for installing flexible, prefabricated sheet membranes in contact with earth or granular fill used as vapor retarders under concrete slabs.

1.2 Conditions subject to frost, heave or hydrostatic pressure, or both, are beyond the scope of this practice.

1.3 *This standard does not purport to address all of the safety concerns, if any, associated with its use. It is the responsibility of the user of this standard to establish appropriate safety and health practices and determine the applicability of regulatory limitations prior to use.*

1.4 The values stated in inch-pound units are to be regarded as the standard. The values given in parentheses are for information only.

### 2. Referenced Documents

#### 2.1 ASTM Standards:

C 33 Specification for Concrete Aggregates<sup>2</sup>

D 224 Specification for Smooth-Surfaced Asphalt Roll Roofing (Organic Felt)<sup>3</sup>

E 631 Terminology of Building Constructions<sup>4</sup>

#### 2.2 Other Standard:

ACI 302.1R Guide for Concrete Floor and Slab Construction<sup>5</sup>

### 3. Significance and Use

3.1 Vapor retarders provide a method of limiting water vapor transmission upward through concrete slabs on grade, which can adversely affect moisture-impermeable or moisture-sensitive floor finishes.

3.2 Adverse impacts include adhesion loss, warping, peeling, and unacceptable appearance of resilient flooring; deterioration of adhesives, ripping or separation of seams, air bubbles or efflorescence beneath seamed, continuous flooring; damage

to flat electrical cable systems, buckling of carpet and carpet tiles, offensive odors, and growth of fungi.

### 4. Manufacturer's Recommendations

4.1 Where inconsistencies occur between this practice and the manufacturer's instructions, conform to the manufacturer's instructions for installation of vapor retarder.

### 5. Placement

5.1 Level and tamp or roll granular base.

5.2 Place vapor retarder sheeting with the longest dimension parallel with the direction of concrete pour.

5.3 Lap vapor retarder over footings or seal to foundation wall, or both, and seal around penetrations such as utilities and columns in order to create a monolithic membrane between the surface of the slab and moisture sources below the slab and at the slab perimeter (see Figs. 1, 2, 3).

5.4 Lap joints 6 in. (150 mm), or as instructed by the manufacturer, and seal with the manufacturer's recommended adhesive or pressure sensitive tape or both.

### 6. Protection

6.1 Take precautions to protect vapor retarder from damage during installation of reinforcing steel and utilities and during placement of concrete.

6.2 Use only concrete brick type reinforcing bar supports, or provide 6 by 6 in. (150 by 150 mm) protective pads of asphaltic hardboard or other material recommended by the vapor retarder manufacturer to protect the vapor retarder from puncture.

6.3 Avoid use of stakes driven through vapor retarder.

6.4 Refer to X2.2 and X2.3 for discussion of aggregate for protection of vapor retarder.

### 7. Repair

7.1 Repair vapor retarder damaged during placement of reinforcing or concrete with vapor barrier material or as instructed by manufacturer.

7.2 Lap beyond damaged areas a minimum of 6 in. and seal as prescribed for sheet joints.

### 8. Suggested Field Check List

8.1 *Moisture Entrapment Due to Rainfall or Ground Water Intrusion*—Moisture entrapment can occur with tilt-up construction or other construction methods where exterior walls are erected before the concrete slab and underlying subgrade, base, or sand/small aggregate layer or combination thereof, are

<sup>1</sup> This practice is under the jurisdiction of ASTM Committee E-6 on Performance of Buildings and is the direct responsibility of Subcommittee E06.21 on Serviceability.

Current edition approved Sept. 10, 1998. Published March 1999. Originally published as E 1643 – 94. Last previous edition E 1643 – 94.

<sup>2</sup> Annual Book of ASTM Standards, Vol 04.02.

<sup>3</sup> Annual Book of ASTM Standards, Vol 04.04.

<sup>4</sup> Annual Book of ASTM Standards, Vol 04.11.

<sup>5</sup> Available from American Concrete Institute, P.O. Box 19150, Detroit, MI 48219.



E 1643

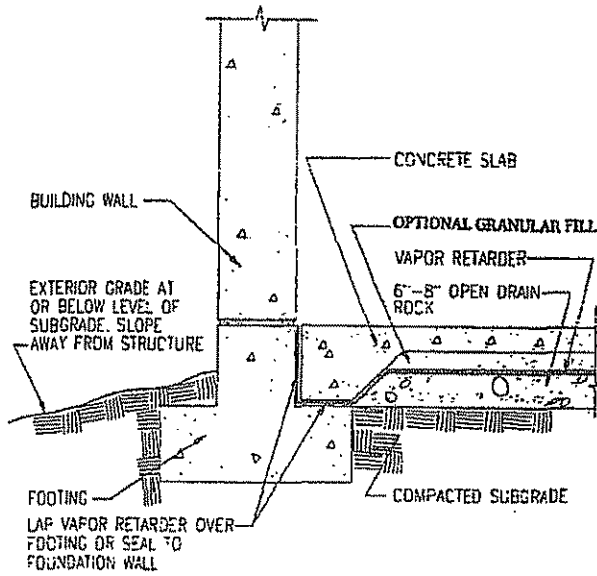

FIG. 1 Concrete Slab on Grade: Optimum Relationship of Vapor Retarder Components

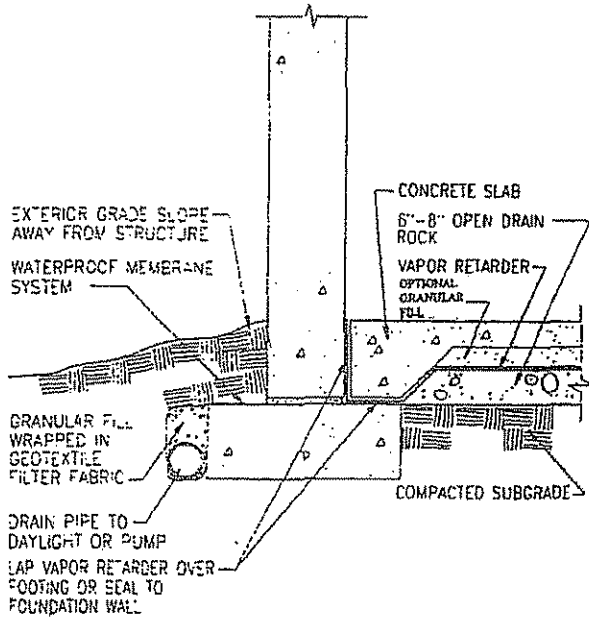

FIG. 2 Concrete Slab on Grade: Solution for Subgrade Slightly Below Exterior Grade

protected from precipitation. This can be avoided by appropriate construction scheduling and sealing of any entry points in uncompleted slabs<sup>4</sup> (see Fig. 4).

<sup>4</sup> Collins, F. Thomas, *Manual of Tilt-Up Construction*, Berkeley, Know-How Publications, 1965, pp 78-81.

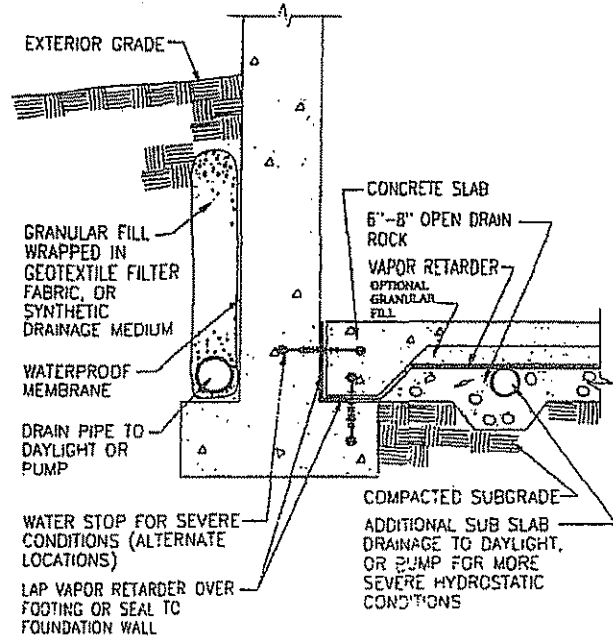

FIG. 3 Concrete Slab on Grade: Solution for Subgrade Up to One Story below Grade with No Hydrostatic Pressure on Vapor Retarder

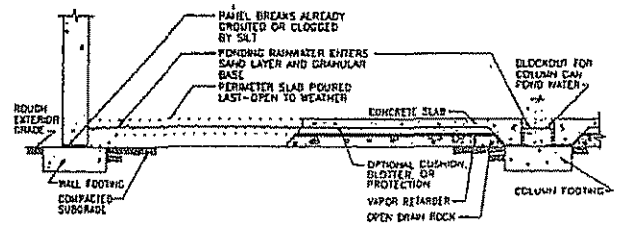

FIG. 4 How Moisture Can Be Retained in Base or Cushion, Blotter, or Protection Course During Construction

8.2 *Integrity of Vapor Retarder*—Check seams and penetrations at columns and utilities to look for discontinuities in the vapor retarder.

8.3 *Damage and Repair*—After installation of reinforcement (if used) but before pouring concrete, check for damage. Do not pour concrete until repairs are made, if required, in vapor retarder. This is particularly difficult if covered with sand or granular fill.

8.4 *Moisture Conditions of Slab*—Following placement of concrete and climatization of building, check to see that any specified tests for moisture emission have been made and a written report submitted prior to floor covering or coating installation.

## 9. Keywords

9.1 concrete slabs; vapor; vapor retarder

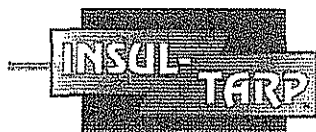

# INSUL-TARP®

## USDL Material Safety Data Sheet

### Material Safety Data Sheet

USDL Safety and Health Regulations OSHA Hazard Communication Standard

#### SECTION 1: PRODUCT IDENTIFICATION

NAME: Insul-Tarp®

DESCRIPTION: Cross Woven Polyethylene/Micro Foam Closed Cell/Cross Woven Polyethylene

PRIMARY: Insulation Solutions, Inc.

ADDRESS: 401 Truck Haven Road  
East Peoria, IL 61611

TELEPHONE: (309) 698-0062

FAX: (309) 698-0065

#### SECTION 2: HAZARDOUS INGREDIENTS

This product is not considered to be hazardous, and is not classified as a controlled product. It comprises principally of polyethylene and micro cell foam, which are non-hazardous.

#### SECTION 3: PHYSICAL DATA

BOILING POINT: Not Applicable

TEMPERATURE RANGE: -60°F to 180°F

APPEARANCE: Flexible Sheet

ODOR: None

SOLUBILITY IN WATER: Insoluble Bulk Weight

#### SECTION 4: FIRE & EXPLOSION DATA

FLAME SPREAD: 10 When Applied

SMOKE DEVELOPMENT: 15 When Applied

EXTINGUISHING MEDIA: Mist Spray, Dry Chemical, Water Fog, Foam, CO<sup>2</sup>

#### SPECIAL FIRE FIGHTING PROCEDURES

Self-contained breathing apparatus and protective clothing should be worn in fighting any fire.

#### UNUSUAL FIRE EXPLOSION HAZARDS

None



# INSUL-TARP®

## OSHA Material Safety Data Sheet

### SECTION 5: REACTIVITY DATA

**STABILITY:** Insul-Tarp® is stable and inert to most chemicals. Does not cause a violent reaction.

**INCOMPATIBILITY:** Consult Insulation Solutions, Inc. prior to using as a containment or barrier for chemicals other than water.

**HAZARDOUS POLYMERIZATION:** Will not occur.

### SECTION 6: HEALTH HAZARD DATA

**THRESHOLD LIMIT VALUE:** Not Established

**EFFECTS OF OVEREXPOSURE:** None Expected

**INHALATION:** None Expected

**EYES & SKIN:** None Expected

**INGESTION:** Insul-Tarp® should not be eaten or kept in contact with food.

### SECTION 7: FIRST AID PROCEDURES

**EMERGENCY FIRST AID PROCEDURES:** If burned by contact with hot plastic, cool and moisten material adhering to skin as quickly as possible with cold water. See physician for removal and treatment of burn.  
DO NOT USE SOLVENTS OR THINNER TO DISSOLVE.

### SECTION 8: SPILL OR LEAK PROCEDURES

**WASTE DISPOSAL METHOD:** Dispose of in accordance with local regulations

### SECTION 9: SPECIAL PROTECTION INFORMATION

Generally, Insul-Tarp® requires no special precaution when handling. However, the product may be slippery when wet, therefore when walking on it care should be taken.

**RESPIRATORY PROTECTION:** None Required

**VENTILATION:** Local Ventilation

**PROTECTIVE GLOVES:** None Required

**EYE PROTECTION:** None Required

### SECTION 10: SPECIAL PRECAUTIONS

Precautions to be taken in handling and storing: Keep away from extreme heat.

### USE GOOD PLANT & FIELD PRACTICES

**NOTE:** THE INFORMATION CONTAINED IN THIS SHEET IS DISCLOSED IN GOOD FAITH AND IS PROVIDED TO THE BEST KNOWLEDGE OF INSULATION SOLUTIONS. IT IS NOT A WARRANTY AND INSULATION SOLUTIONS ASSUMES NO RESPONSIBILITY FOR DAMAGES INCURRED FROM THE USE OR INABILITY TO USE THIS PRODUCT.



# INSUL-TARP®

Non-Radiant Test Data Sheet

## HEAT FLOW METER THERMAL TRANSMISSION TEST REPORT

Rendered To:

INSULATION SOLUTIONS, INC.  
401 Truck Haven Road  
East Peoria, IL 61611

**Project Summary:** Insulation Solutions® contracted a certified independent laboratory to conduct thermal conductance/conductivity testing on Insulation Solutions® Insul-Tarp® slab configuration DRFB.5.

The specimen was tested in accordance with ASTM C 518-02, *Standard Test Method for Steady-State Heat Flux Measurements and Thermal Transmission Properties by Means of the Heat Flow Meter Apparatus*. Test specimen description, data and results are reported herein.

**Test Method:** The test specimen was evaluated in accordance with the general requirements of ASTM C 518-02, with the exception that results are reported in English units. The test method covers the measurement of steady state thermal transmission through flat specimens using a heat flow meter apparatus. This is a comparative method of measurement and must be calibrated to specimen traceable to a recognized National Standards Laboratory. The apparatus was calibrated with standard Reference Material 1450c dated March 5, 1997 supplied by the National Institute of Standards and Technology.

### Specimen/Project Description:

Series/Model: Insul-Tarp Slab Configuration DRFB.5

Configuration: Four inch concrete slab, 1/2" insulation, 2" gravel/rock, 1" sand

### Testing Conditions:

The specimen had 7/16" plywood bottom, with an R-Value of 0.372.  
This R-Value was subtracted from total product R-Value.

Cold plate temperature: 55°F nominal  
Warm plate temperature: 75°F nominal  
Mean plate temperature: 65.0°F nominal  
Vertical heat flow (Down): Horizontal specimen  
Specimen average thickness: 8.0"  
Specimen average density: 78.75 lbs/ft<sup>3</sup>  
Average thermal resistance (R): 7.54 hr·ft<sup>2</sup>·°F/Btu  
Average thermal resistance (Rsi): 1.33 m<sup>2</sup>·K/W

[www.insulationsolutions.com](http://www.insulationsolutions.com)



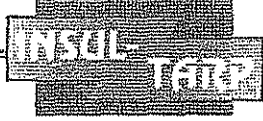

# INSUL-TARP®

On-Site Photos

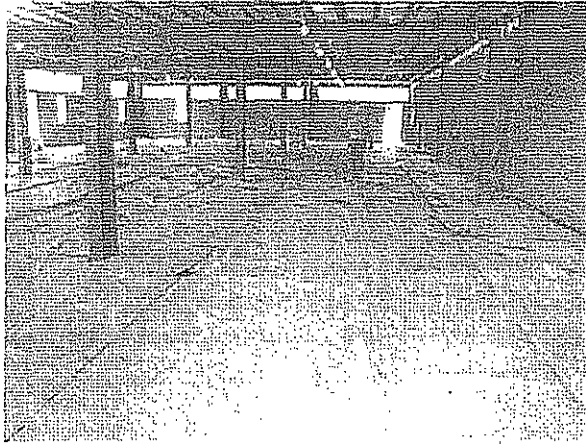

SHIPPING FACILITY, NEW ENGLAND



POST FRAME BUILDING, ILLINOIS

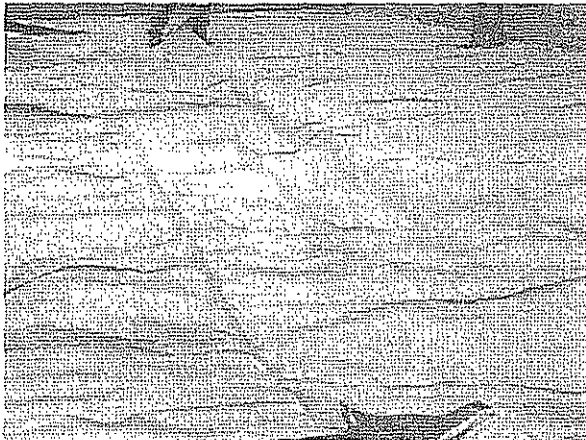

RESIDENTIAL HOME, ILLINOIS

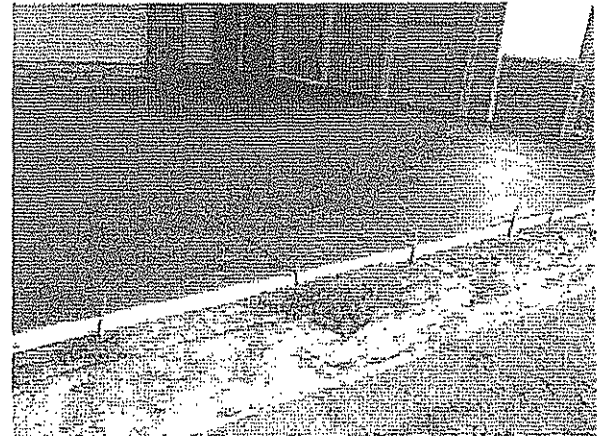

POST FRAME BUILDING, ILLINOIS



# INSUL-TARP®

## On-Site Photos

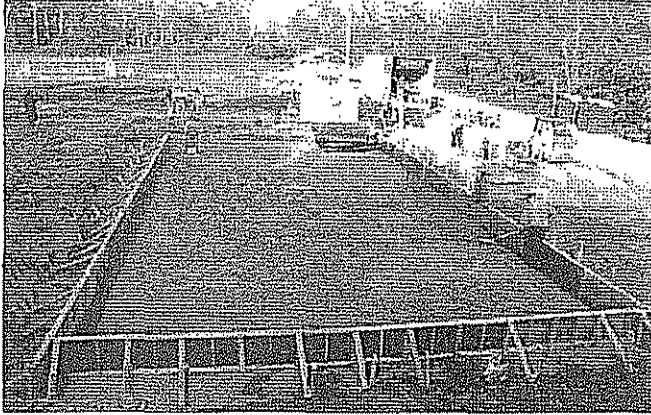

STRAW BALE HOME, ARIZONA

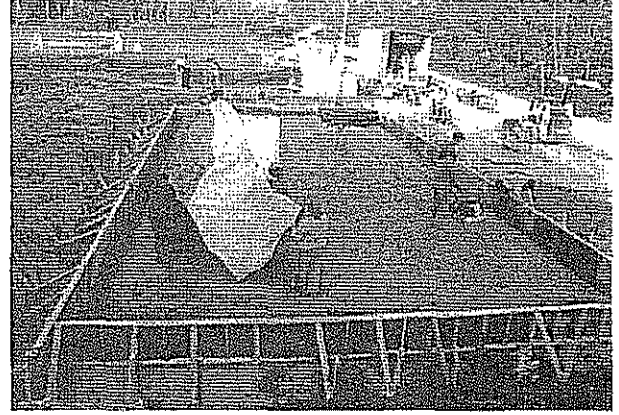

LAYING DOWN INSUL-TARP

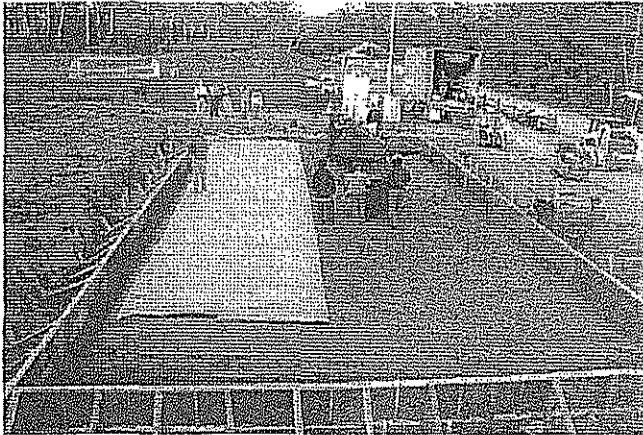

OVERLAPPING THE INSUL-TARP

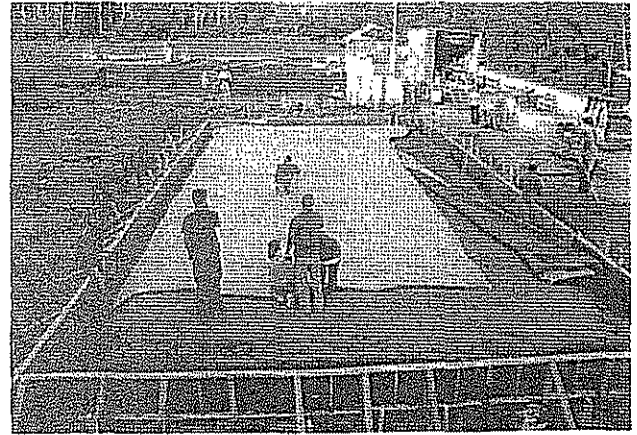

TAPING THE SEAMS

**NOTES:**



# **EXHIBIT 3**



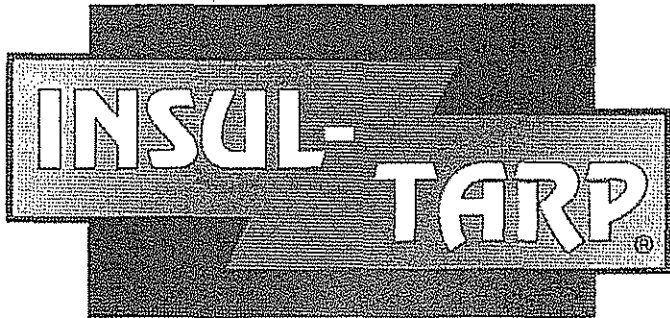

# RADIANT

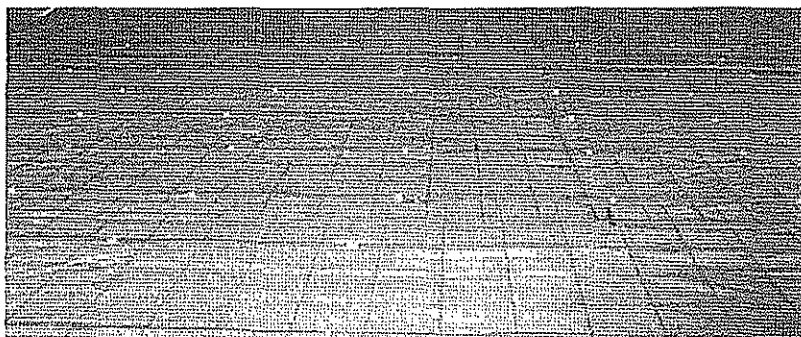

*Insul-Tarp®*, as shown here, has been rolled out and installed with radiant tubing clipped to wire mesh.

## Your Answer for Under-Slab Insulation

**Residential**

**Commercial**

**Agricultural**

Insulation Solutions, Inc.  
An Affiliate of Meyer Enterprises, LLC  
401 Truck Haven Road  
East Peoria Illinois 61611  
Toll Free: 866.698.6562  
Ph: 309.698.0062  
Fax: 309.698.0065  
[www.insulationsolutions.com](http://www.insulationsolutions.com)





# INSUL-TARP®

## Table of Contents



<b>PRODUCT INFORMATION.....</b>	<b>1</b>
<b>BENEFITS.....</b>	<b>2</b>
<b>ADVANTAGES.....</b>	<b>6</b>
<b>INSTALLATION INSTRUCTIONS.....</b>	<b>7</b>
<b>ON-SITE PHOTOS.....</b>	<b>10</b>
<b>TESTIMONIALS.....</b>	<b>12</b>
<b>TESTING:</b>	
<b>-INTRODUCTION.....</b>	<b>16</b>
<b>-TEST DATA SHEET.....</b>	<b>17</b>
<b>-CASE STUDIES.....</b>	<b>18</b>
<b>-LAB TESTS.....</b>	<b>25</b>
<b>MATERIAL SAFETY DATA SHEET.....</b>	<b>31</b>





# What is INSUL-TARP®?

**Insul-Tarp®** is a patented, revolutionary product like no other on the market today. Its lightweight, Space Age design integrates closed cell foam, an aluminum reflective material with a protective poly coating, all within three, thin layers. The durable poly coating protects the insulation material from potentially damaging surfaces and is impermeable to moisture, helping it to maintain a high R-Value in a minimal amount of space. The superior physical characteristics and overall design of **Insul-Tarp®** make it the most effective product for insulating under concrete slabs in residential, commercial and agricultural radiant heating systems.

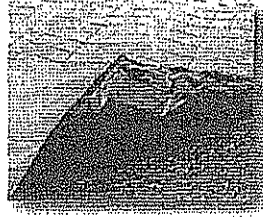

**Insul-Tarp®**'s innovative combination of layers and reflective material enable it to effectively control all three modes of heat transfer: Conduction, Convection and Radiation, improving the performance of the radiant heating system and providing higher slab temperature output.

**Insul-Tarp®** insulation was designed specifically for under-slab applications. **Insul-Tarp®** provides excellent thermal performance and a vapor barrier, all in one easy to use product. In most applications the ground temperature that the insulation is directly exposed to is a consistent 50-55°. Rigid insulation will eventually stabilize at that temperature level. Therefore, the rigid insulation provides a consistent drain on the radiant system and the slab. Because of the innovative combination of layers of insulation and aluminum, **Insul-Tarp®** allows the slab to reach a desired temperature faster; therefore the heating system performs more efficiently. **Insul-Tarp®** stands alone!

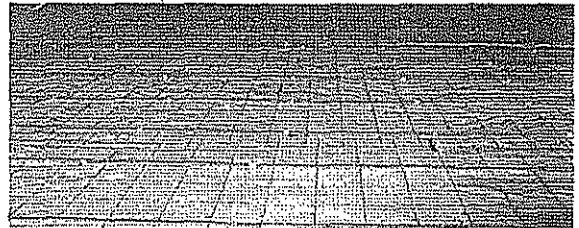

**Insul-Tarp®**, as shown here, has been rolled out and installed with radiant tubing clipped to wire mesh.

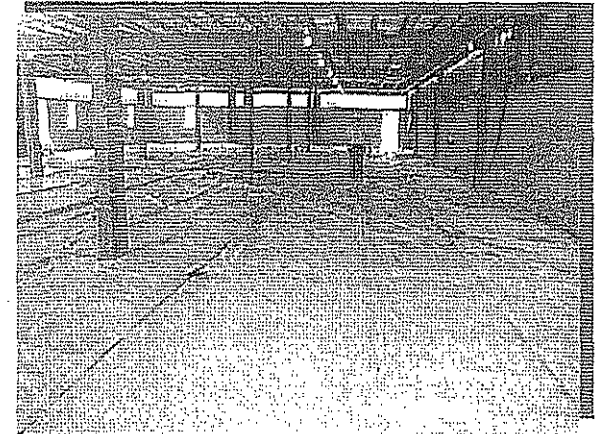

**Insul-Tarp®**

- **Easy to Install**  
Lightweight, minimal seaming, rolled into place
- **Greater Profits**  
Competitively priced  
Installed in a fraction of the time
- **Consistent Performance**  
Not affected by moisture or humidity  
R-Values remain consistent over time
- **The Right Choice**  
**Insul-Tarp®**'s reflective insulation technology leaves all other insulation practices out in the cold. When you install **Insul-Tarp®**, you can rest assured that you are using the best product available for your under-slab insulation needs.

**Insul-Tarp® Roll Sizes:**

- |                      |                   |
|----------------------|-------------------|
| **12' X 50' = 50lbs. | 6' X 50' = 25lbs. |
| **12' X 25' = 25lbs. | 6' X 25' = 12lbs. |

\*\*12' rolls consist of (2) 6' rolls seamed together.  
Widths on these rolls may vary.

Note: On any roll size, always estimate 10% extra to ensure you order enough for proper coverage.

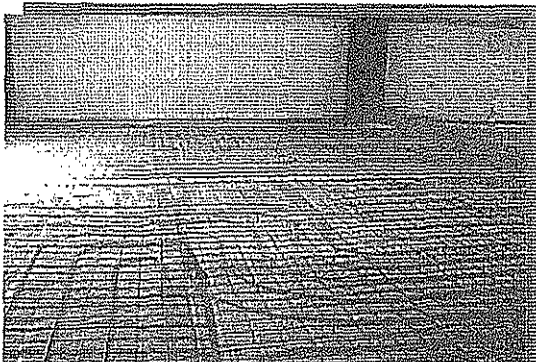



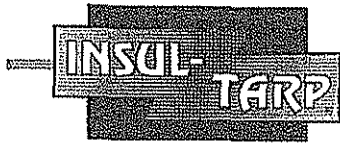

# INSUL-TARP®

## Benefits

- **Easy to Handle**

Lightweight *Insul-Tarp®* rolls come in four sizes: 6' x 25', 6' x 50', 12' x 25' and 12' x 50'. *Insul-Tarp®* can be carried and installed by one person.

- **Quick Installation**

*Insul-Tarp®* can take less than one-tenth of the time of conventional insulation to install. While rigid insulation requires the subsoil to be lowered and leveled, no special preparations are needed to accommodate *Insul-Tarp®*. It conforms itself to the subsoil providing a perfect fit. Installation around areas such as plumbing is almost effortless. Simply cut an "X" in the tarp and slide it over the pipe. Less time, less mess and less effort is the end result.

- **Quick Response Time**

With *Insul-Tarp®*, the response time of the heating system is quicker and more consistent due to the insulation's superior reflective properties. *Insul-Tarp®* significantly decreases heat loss to the earth below the slab, allowing the system to react more efficiently and accurately to a shift in temperature. A quicker response time means a happier customer!

- **More Comfort with All Types of Heating Systems**

An un-insulated foundation and slab can result in a large heat loss from an otherwise tightly sealed, well insulated home. It can also make below-grade rooms uncomfortable. *Insul-Tarp®* on the other hand, can lower heating requirements and help control moisture condensation, which is often by the difference in temperature between the concrete and the earth around it. Insulating the concrete monolithic slab can prevent significant energy loss from the building. Insulating under-slab not only helps in reducing energy loss in the winter, but will also help reduce summer condensation.

When insulating with *Insul-Tarp®* under-slab insulation, the temperature of the slab will increase with the room temperature. The heat in the concrete slab will be retained longer, ensuring a warmer, more comfortable building. Studies have shown that up to 30% of a building's heating and cooling energy can be pulled right out of the building with an un-insulated slab.

Heat loss studies by Paul D. Isaacson show that an un-insulated slab floor can lose up to 46 BTU's of heat per square foot, per hour. Denny of D&M Builders measured heat loss on his cement slab floor by placing a thermometer on the floor in various places. He measured a whopping 15° difference between the insulated and un-insulated part of the slab.

It is important to know that in most applications the ground temperature that the insulation is going to be directly in contact with is a constant 55° lower all year round. Rigid insulation such as foam board, even though they may have R-Values, will eventually stabilize at 55° or lower depending on the climate. Therefore, the rigid insulation provides a constant drain on the slab.

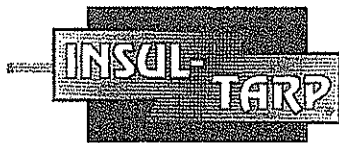

# INSUL-TARP®

## Benefits

- **Integrated Vapor Barriers**

Concrete is a mineral/salt rich porous material full of tiny channels and voids. These pathways are just right for the migration of fluids and vapors. Migration is due to simple physics; forces working to achieve temperature, humidity, concentration, or pressure (hydrostatic) equilibrium. There is more to it than simple equilibrium induced fluid migration. Dissolved metal salts in the migrating water can form relatively large calcium/potassium silicates (in a typical alkali-silica reaction) upon reaching the concrete surface.

In many areas of the country, it is typical to place a polyethylene vapor barrier under the slab as a solution. Too often though the polyethylene sheeting is torn by foot traffic during finishing. The purpose of a vapor barrier is to eliminate rising dampness from the sub-grade. Compared to the atmosphere above the slab, the interior of a concrete slab is a high-pressure area. Moisture vapor can travel through the interior pore system of the concrete and reach the surface and condense into liquid water under the floor covering. Floor coverings do not perform well when underlain with a minimum, but persistent supply of liquid water. Carpet dampens, vinyl tile loses its bond, urethanes age due to the high pH levels of the rising water and epoxies can become cloudy in appearance.

- **Better IAQ (Microorganisms and Health Effects)**

Many buildings also have mold problems and musty odors, which are caused by water vapor entering through the concrete. This vapor can elevate humidity levels, supporting growth of mildew and other microorganisms. Mold and mildew are essentially the same thing. These are more plant in nature than animal. A fungus, however, is actually neither pure plant nor pure animal; therefore falling into a kingdom of its own. Other microorganisms are viruses, which are free-standing chemicals and bacteria. Unlike mold and mildew, viruses are more animal in nature than plant. While viruses and bacteria are dangerous organisms they are low on the Indoor Air Quality (IAQ) scale. However, fungi ranks number one as the most problem IAQ component. When moisture is present for a two-day period or longer there may be as many as 2000 different species of fungi spores that will begin to grow. In order for one species of fungi to compete with another, each species produces toxins that are designed to poison the other species. According to one source from Florida, who was the head of the US Army Biological Weaponry for more than twenty years, three of the toxins, which are produced during this process, are banned by the International Peace Treaty to be used as biological weapons.

- **Radon Gas Barrier**

Radon is one of several things that can seep from the soil beneath a concrete foundation into a building. Pressure differences can force radon, methane, water vapor, termiticides, herbicides and other gases through any concrete foundation into the building. The best way to minimize this is by using a highly effective and durable vapor barrier such as *Insul-Tarp*®.

Radon gas is defined in the Merriam-Webster dictionary as follows: "a heavy radioactive gaseous element formed by the decay of radium." Radon gas can be found everywhere in the United States as well in basically every particle of soil on the planet. Human beings cannot detect radon gas with any of the five senses.



# INSUL-TARP®

## Benefits

**The Surgeon General was warned that radon is the second leading cause of lung cancer in the United States.** Mounting evidence points to radon in homes and buildings as an important public health problem, causing as many as 21,800 deaths annually from lung cancer.

Dr. Harley, a research professor in the Department of Environmental Medicine at the New York University of School and Medicine explains that radon infiltrates a structure by seeping in through cracks in the foundation or through the concrete slab that forms the basement or ground floor of a building.

Dr. Harley said lower pressure in the basement creates a vacuum of sorts that sucks air and radon gas up through the floor and into the home. Since the potential exists for at least some radon to be in almost every home, Dr. Harley said, "It is probably wise for most homeowners to have a radon test at one point or another."

### Termite Attraction to Foam Board

Termites are not ants. They are close relatives of cockroaches and date back 200 million years. They are prolific breeders, well organized societies and hard to kill. Their nests can be as far as seventy-five yards away from a home, in a tree or underground. Termites attack both soft and hard woods. Homeowners do not usually become aware of an attack until it's too late, like when wooden posts or walls suddenly collapse, even roofs. Termites cause billions of dollars of property damage annually. When they pay you a visit they are your worst nightmare.

Eliminating sources of chronic moisture in the home is one of the most important factors in managing termites, carpenter ants and some wood boring beetles. Moist soil is necessary for termites to survive. Termites travel back and forth between soil and food sources because they must obtain moisture from the soil. In addition, capillary action and water vapor buildup can result in excessive dampness, which actually wick through a concrete slab or masonry foundations to the wood framing above it, thus attracting termites.

Most experts recommend the use of moisture barriers under slab foundations. A moisture barrier such as *Insul-Tarp*®, because of its unique design of durable cross woven poly and aluminum skins, can be used to cover the area under the structure. This will help decrease moisture buildup directly under the slab. Some studies in California have found physical barriers, such as *Insul-Tarp*®, to be 15% more effective than chemical treatments.

There's a relatively new and troubling concern in the building industry today. It has to do with termites and foam insulation. "In the field, we're finding the problem more of a challenge in heavily infested areas where foam insulation is in contact with the ground," said Tim Grether, manager of building materials technical service at Owens Corning. "The termites nest in or tunnel through the material."

Jim Herron, the head of the Structural Pest Control Commission at the Georgia Department of Agricultural was interviewed and stated, "The idea of putting Foam Board around the foundation of some Georgia homes first sounded like a good idea in an effort to save energy, but the potential energy savings didn't outweigh the negative consequences."

"The foam board seemed to attract termites like a magnet to metal," quoted Colin White, the President of Perimeter Termite and Pest Control. With an entry point as small as 1/32 of an inch, a termite can gain entry to your home.



# INSUL-TARP®

## Benefits

Because of this problem, some building codes now prohibit the use of all types of foam insulation in contact with the ground. Two U.S. model building codes, CABO and SBCCI, have developed requirements for the uses of foam board. South Central and South Eastern U.S. now prohibits the use of foam board on the exterior face, under interior or exterior below-grade foundation walls, and in slab foundations where wood is found in the structural components of construction. "A word of warning to anyone building a home in South Carolina; don't use foam to insulate the foundation below the ground. That only invites termites to dine on your house," according to Neil Ogg, Assistant Head of Clemson University's Department of Pesticide Regulation (DPR).

**Slab-on-ground installation:** After the dirt or gravel fill preparation is completed, treat this soil with the termiticide just before covering it with *Insul-Tarp*® and the concrete. Uniformly apply, by sprayer or sprinkling can, the amount of liquid termiticide called for on the label. The treated soil must not be disturbed before laying the *Insul-Tarp*®. The *Insul-Tarp*® should be applied as soon as possible after the termiticide to minimize chemical breakdown caused by sunlight. For the treatment of soil beneath concrete floors in the basement, follow the same procedures as outlined for slab-on-ground construction.

**Existing slab-on-ground homes:** The control of infestation occurring beneath concrete floor slabs on the ground is difficult and sometimes hazardous. For this reason, the average homeowner should not attempt it. This is especially true where radiant heating systems are involved. Pipes are likely to be buried in the concrete and may be damaged when holes are drilled in the floor to inject a termiticide into the soil below. Because of this reason it is very important in a new construction project to install *Insul-Tarp*® to protect against major problems in the future.





# INSUL-TARP®

## Advantages

### Insul-Tarp Advantages Over Foam Board

<b>Insul-Tarp</b>	<b>Foam Board</b>
Lightweight & Easy to Carry.....	Requires Careful Handling
Easily Stored on Job Site.....	Should be Secured on Job Site
Minimal Excavation.....	Additional Excavation
Conforms to Subsoil.....	Requires Level Subsoil
Extremely Durable.....	Fragile & Easily Damaged
150-600 sq. ft. Rolls.....	32 sq. ft. Maximum
Quicker Installation.....	Install One Board at a Time
Easy to Cut & Modify with Scissors/Utility Knife.....	Requires Special Cutting Tools
Grommets in the Side Flanges.....	No Grommets
Fewer Seams = Minimal Taping.....	More Seams = Added Taping
Pex Staples Perform Well.....	Pex Staples Perform Well
Effective Vapor Barrier.....	Secondary Barrier Needed
Effective Radon Barrier.....	Secondary Barrier Needed
Reflects Radiant Heat Transfer.....	Absorbs Radiant Heat Transfer
Faster Response Time.....	Slower Response Time



# INSUL-TARP®

## Installation Instructions

**Insul-Tarp® has been designed to be installed quickly and easily by following a few easy steps.**

- 1) **Insul-Tarp®** comes to the customer in roll form. Simply cut the retaining tape with a utility knife or scissors and unfold the tarp.
- 2) Install **Insul-Tarp®** with the white side facing up.
- 3) Adjust the tarp to where it is square and install the next tarp. The tarps should be overlapped at the seams. Make sure that you have insulation to insulation. For a continuous vapor barrier, seams should be taped using an appropriate tape product.
- 4) When coming to an obstruction such as plumbing, simply put the tarp up to the obstruction, with scissors or a sharp utility knife, cut an "X" in the tarp. Slide the tarp over the obstruction and continue. When cutting the tarp to size, use scissors.
- 5) **Insul-Tarp®** is manufactured with grommets in the side flanges. These grommets can be used to tie down the tarps in windy conditions.
- 6) If air pockets occur, when pouring the concrete slab, simply cut a slit in the top layer of the tarp to release any trapped air. Then place a piece of appropriate tape over the slit and continue pouring.

### Helpful Hints

- When cutting **Insul-Tarp®** always use scissors and install the cut edge under the factory edge. If factory edge is not available, simply tape the edge of the tarp.
- When installing **Insul-Tarp®** on a sunny day, make sure to wear a pair of sunglasses as **Insul-Tarp®** will reflect the sun's rays.
- When ordering square footage for a project, add **10%** for overlap and seamed edges. **Insul-Tarp®** is designed with a 2" vapor seam around the tarp. This overlap provides for an effective vapor/moisture barrier. **Note:** Actual size of **Insul-Tarp®** may slightly vary in length and width.

# INSUL-TARP®

## Installation Drawings

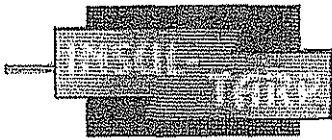

**Floating Slab on Grade with Exterior Perimeter Insulation**

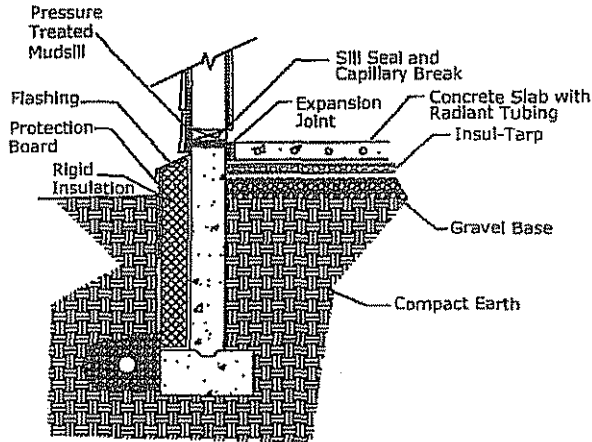

**Monolithic Slab on Grade with Exterior Perimeter Insulation**

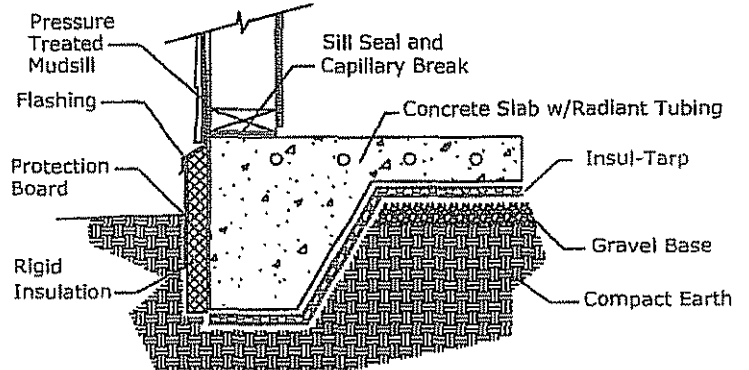

**Thermal Break Between Slabs of Heated and Unheated Floor Spaces**

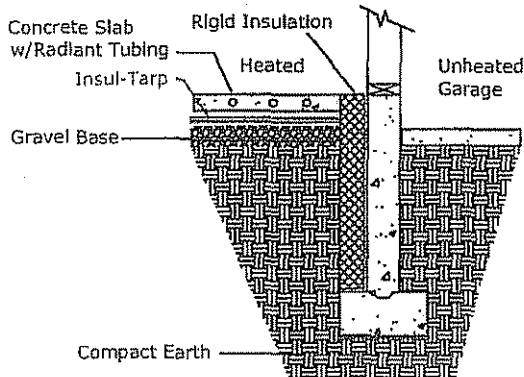

**Thermal Break Between Slabs of Heated and Unheated Floor Spaces**

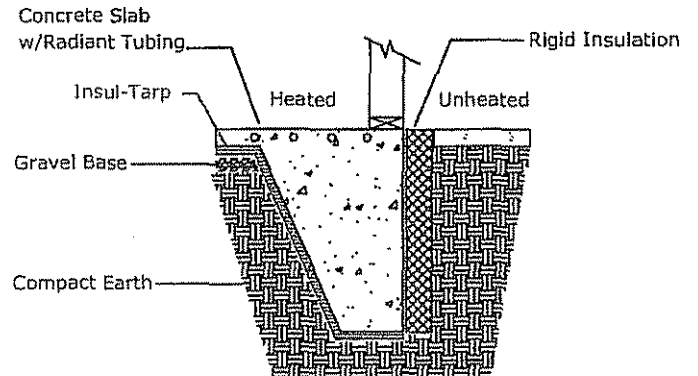

**Thermal Break Between Slabs of Heated and Unheated Floor Spaces**

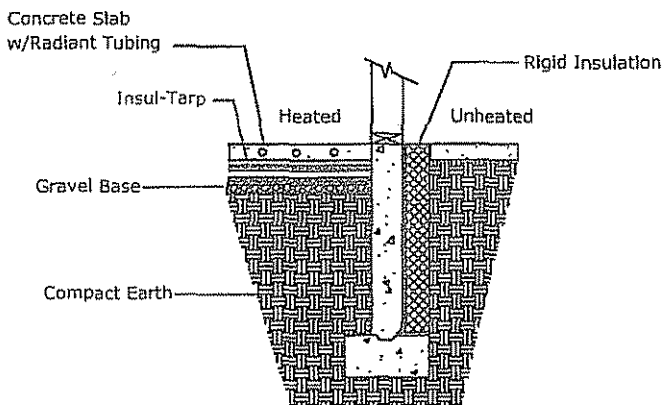

**Thermal Break Between Heated Space Slabs and Unheated Crawl Space**

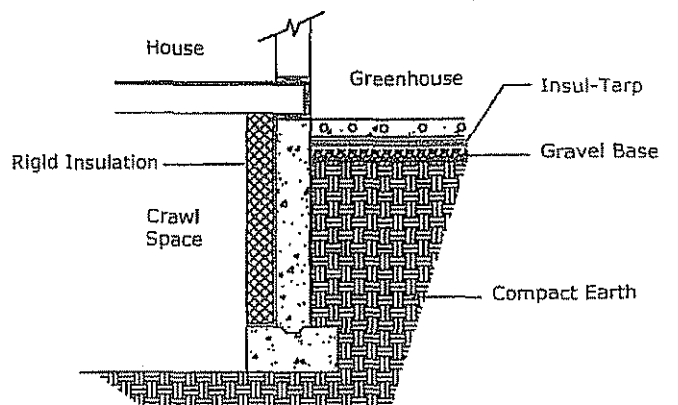

# INSUL-TARP®

## Installation Drawings

**Insul-Tarp Cut and Taped Around I-Beam**

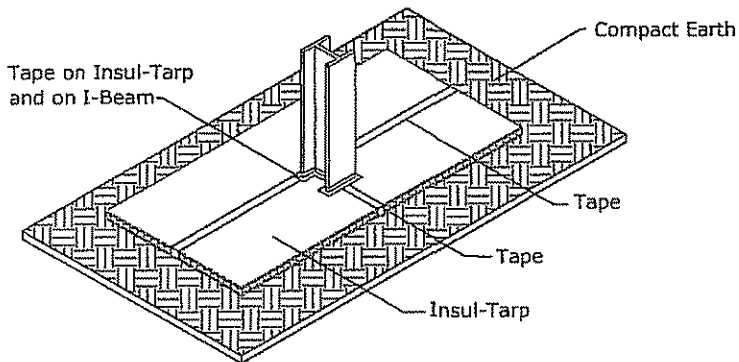

**Insul-Tarp Cut and Taped Around Pipe**

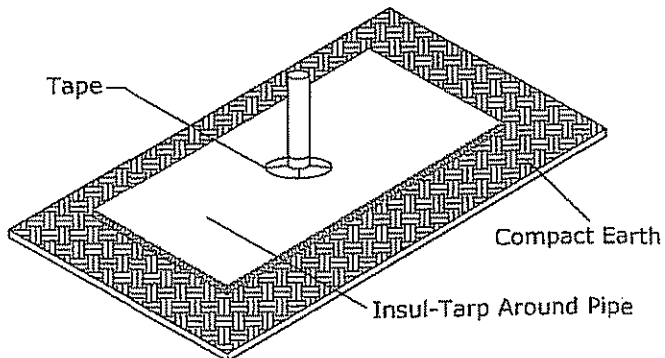

**Depressed Footing Detail 1**

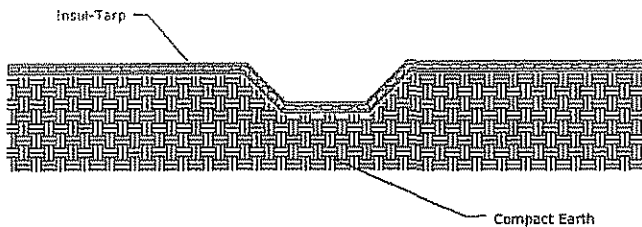

**Depressed Footing Detail 2**

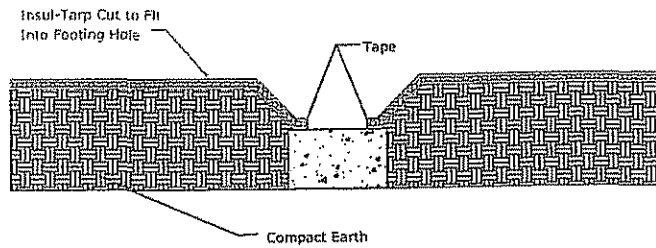

**Foundation Wall Taping Detail**

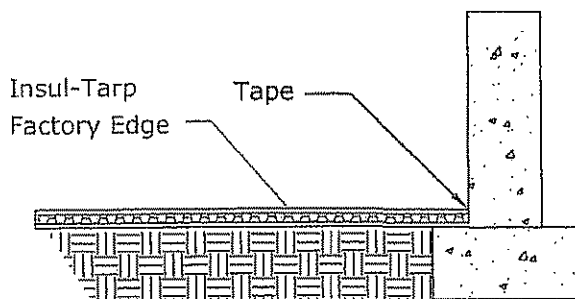

**Overlap Taping Details**

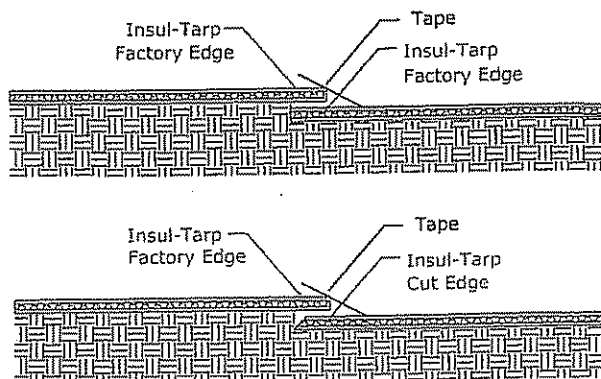



# INSUL-TARP®

## On-Site Photos

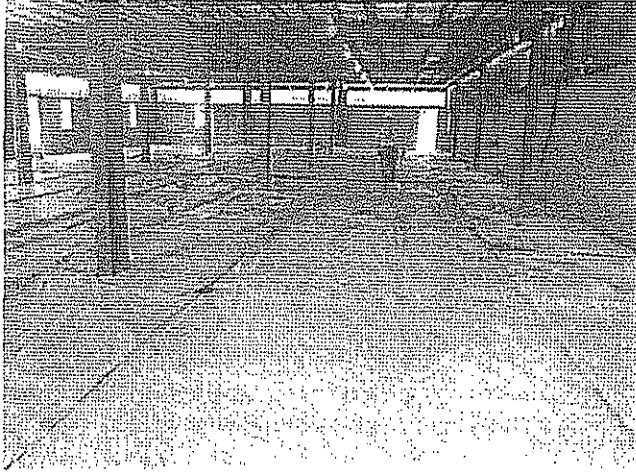

SHIPPING FACILITY, NEW ENGLAND



MONOLITHIC SLAB FOR A STRAW BALE HOME, ARIZONA

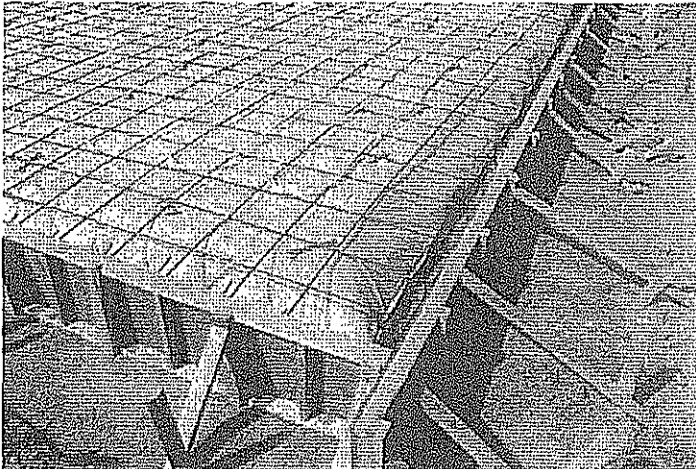

MONOLITHIC SLAB FOR A STRAW BALE HOME, ARIZONA



RADIANT JOB, MASSACHUSETTS





# INSUL-TARP®

## On-Site Photos

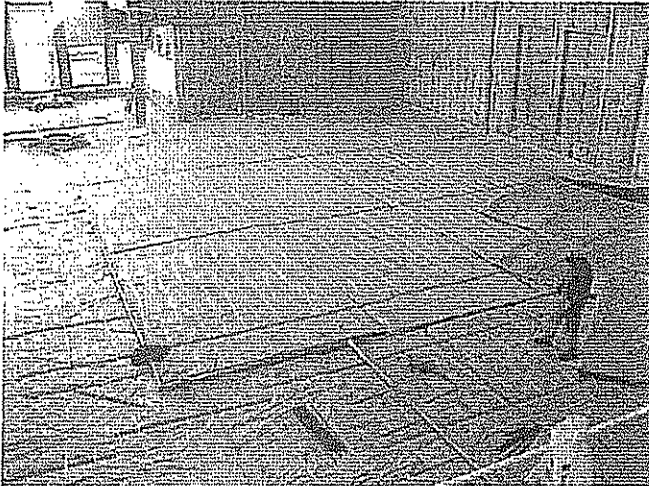

CHURCH, IOWA

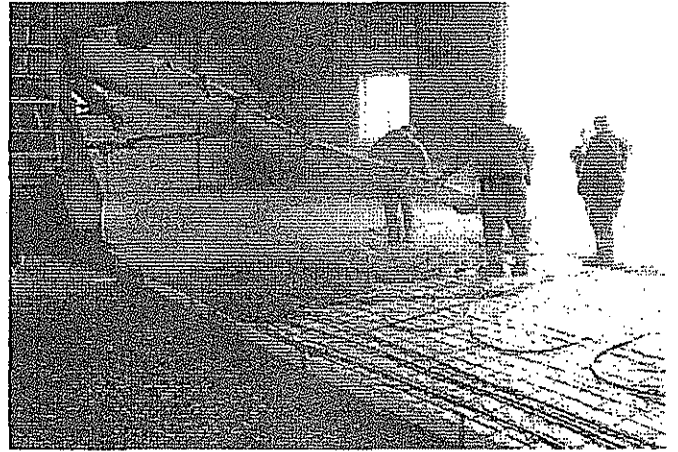

POST FRAME BUILDING, ILLINOIS

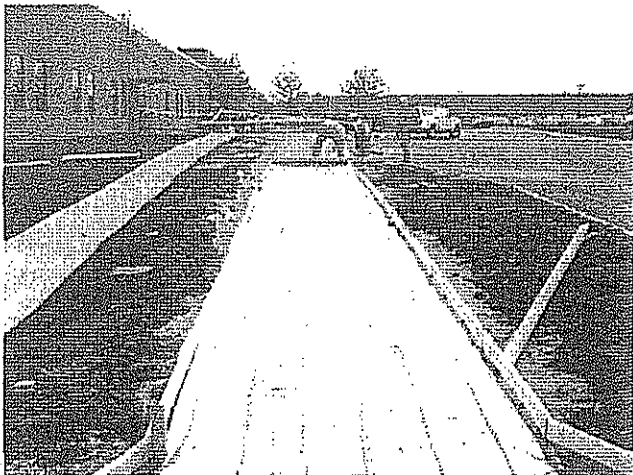

SNOW MELT PROJECT, MINNESOTA



RESIDENTIAL HOME, ILLINOIS

***Hi Valley Supply***

2045 W. Amherst  
Englewood, CO 80110  
303-762-9614  
303-762-0588 fax

Don Meyer  
Meyer Enterprises, L.L.C.  
456 W. Camp Street  
East Peoria, IL 61611

Dear Don,

Our company has been on the cutting edge of technology in the field of radiant floor heating. We always strive to provide our customers with the best available products. When we find a new product we like to test it out, whether it is a boiler, side-arm tank, control system, tubing or insulation. We do many projects a year, and our customers have tried out many products. Insul-tarp was one of these products tested by us.

Before using Insul-tarp we were promoting the use for 2" foundation approved polystyrene. We had promoted the use of this product for years, and have several hundred applications installed with this product. Most of our contractors left it up to the general contractor to install the insulation.

Since the introduction of the 1/2" Insul-tarp to our customers, many of, which were skeptical, yet wanted to try this new product or let their general contractors try this product. The results were amazing, the time it took to install insulation under a slab was greatly reduced, the grade of the project did not have to be perfectly flat, the project did not have to be excavated the extra 1-1/2", and the ease of installation. The absolutely incredible part of Insul-tarp, was the performance we have seen during heat up times of the slab. Projects that were done with 2" polystyrene seem to take up to 30% longer to get up to temperature. We have projects in which Insul-tarp was installed, and during the initial fire up of the system, these slabs came up to temperature in record times during some of the coldest months of the year in the Colorado Mountains.

Our customers that have tried the Insul-tarp product know that it works. This product performs better than any other product we have tried. We look forward to the continued use of this product as one of our primary lines in radiant heating. Thank you for providing a product that does what it is supposed to do.

Sincerely,

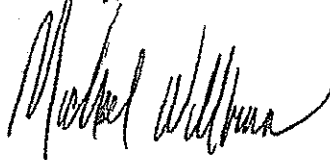

Michael E. Willburn  
Sales & Technical Support



---

December 27, 2001

Donald Meyer  
Insulation Solutions, Inc.  
456 W. Camp St.  
East Peoria, IL. 61611

Dear Don,

I would like to take a moment and give you some product feedback. We have had the product Insul-Tarp as part of our product line for one year. It has quickly become one of our fastest selling products. We combine the product in most cases as part of a radiant heating system package. We find it to be the best alternative to rigid foam since it can be installed in one tenth of the time. The cost saving to the customer is substantial since the product cost per square foot is close to rigid foam.

Our customers are also finding other ways to use the product, like wall insulation for a pig barn. The customer needed something that was durable and easy to clean. He didn't heat the structure but just wanted some protection from the elements. Insul-Tarp provided an excellent solution.

I recommend the product highly and find it to be a profitable part of our product line. We look forward to expansion of our marketing with Insul-Tarp, I think it has huge potential in all phases of the construction market.

Sincerely,

A handwritten signature in black ink, appearing to read "Doug Mossbrook", is written over a printed name and title. The signature is stylized and fluid.

Doug Mossbrook  
President, Eagle Mountain Inc.





P.O. Box 4051  
Buena Vista, CO 81211

November 5, 2001

RE: Testimony on Insul-Tarp verses 2" Foam Board

Traditionally our heat systems have been installed over 2" foam board insulation. A typical wintertime start up would take 2-3 days to bring the house up to temperature.

In January of 2000 we did our first system with Insul-Tarp. We used it in a 2500 square foot log home on Tennessee Pass in Colorado. The house is located at about 11,500 in elevation.

The day we started the system up was during one of the colder weeks of that year, high temperatures were probably 25-30 degrees and night time lows were probably -10 to -15 degrees, not including wind chill. By the time we filled the system and fired it off, it was about 2:00p.m. After making sure the system was operating properly we left the job site about 3:30 p.m. Upon returning to the job site the next morning about 8:30 a.m. we found that during the evening sometime the system had come up to temperature and satisfied the thermostat which was set at 75 degrees.

Martin L Naffziger



# plumbing supply co.

DISTRIBUTING KITCHEN, BATH & HEATING SUPPLIES

www.activeplumbing.com

**PAINESVILLE...MAIN OFFICE**  
216 RICHMOND STREET  
PAINESVILLE, OHIO 44077  
PHONE (440) 352-4411  
FAX (440) 352-0096

**CLEVELAND**  
239 BROOKPARK ROAD  
CLEVELAND, OHIO 44109  
PHONE (216) 459-2700  
FAX (216) 459-0268

**WILLOUGHBY**  
38033 ELM STREET  
WILLOUGHBY, OHIO 44094  
PHONE (440) 953-1532  
FAX (440) 953-0649

**BAINBRIDGE**  
9890 E. WASHINGTON STREET  
BAINBRIDGE, OHIO 44023  
PHONE (440) 543-2233  
FAX (440) 543-7905

**ASHTABULA**  
1220 LAKE AVENUE  
ASHTABULA, OHIO 44004  
PHONE (440) 964-7575  
FAX (440) 964-7449

October 20, 2004

Attn: Donald L. Meyer, President/CEO

Re: Testimony on Insul-Tarp versus 2" foam board

Traditionally our heating systems have been installed over 1" or 2" foam board. A typical wintertime start up would take 2-3 days to bring the house up to temperature.

In February 2002, we did our first system with Insul-Tarp. My Customer used 1800 square feet for an office building at a nursery located on Lake Erie, in Lake County, Ohio.

My customer was very worried about the new Insul-Tarp, since winds off of the lake have a wind chill factor of -15 to -20 degrees. We also used an instantaneous water heater with pex pipe for the slab. My customer filled the system and started it up at 5:30 pm when leaving the job. At 8:30 am the next day when he returned, he found the office building temperature 70 degrees and the system had shut down. My customer called me at once to let me know that he did not need the 2 to 3 days running time. Insul-Tarp made the difference.

Sincerely,

Clay Curtis  
Heating Dept.  
Active Plumbing Supply

CC/lms

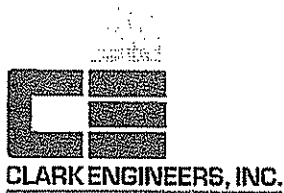

April 12, 2003

Mr. Don Meyer  
Insulation Solutions  
2711 N. Main St.  
East Peoria, IL 61611

RE: Insulation Solutions Case Studies and Test Evaluations

Dear Mr. Meyer

We are pleased to provide you with the following conclusions regarding the information and data presented in your Insulation Solutions Product Catalog.

On behalf of Clark Engineers, Inc., we have reviewed the presented data and information and find it to be consistent and accurate in evaluating product performance characteristics. The Insulation Solutions "InsulTarp" product has proven itself through numerous tests, case studies and evaluations to be an exceptional product and outperforms similar materials based upon the presented material. While this is not an official endorsement, but rather a performance based evaluation, we would concur that your product is superior in many ways as compared against those tested.

As a consulting engineering firm involved in the design of building heating, ventilation and air-conditioning systems on a daily basis, we understand the importance of client comfort. We can see the absolute benefit to using the "InsulTarp" product to increase the surface temperature of a heated floor. This not only reduces energy costs, but maximizes comfort, something that is difficult to put a dollar value to and sometimes, even more important than any cost comparisons.

We wish you well with your product and look forward to hearing of your success in the near future.

Sincerely,

CLARK ENGINEERS, INC.

A handwritten signature in cursive script, appearing to read 'Robert W. Furgeson'.

Robert W. Furgeson, P.E.  
Manager, Facility Engineering Group

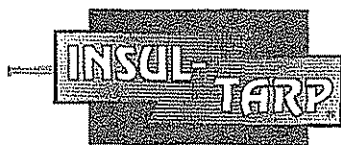

# INSUL-TARP®

## Non-Radiant Test Data Sheet

### HEAT FLOW METER THERMAL TRANSMISSION TEST REPORT

Rendered To:

INSULATION SOLUTIONS, INC.  
401 Truck Haven Road  
East Peoria, IL 61611

**Project Summary:** Insulation Solutions® contracted a certified independent laboratory to conduct thermal conductance/conductivity testing on Insulation Solutions® Insul-Tarp® slab configuration DRFB.5.

The specimen was tested in accordance with ASTM C 518-02, *Standard Test Method for Steady-State Heat Flux Measurements and Thermal Transmission Properties by Means of the Heat Flow Meter Apparatus*. Test specimen description, data and results are reported herein.

**Test Method:** The test specimen was evaluated in accordance with the general requirements of ASTM C 518-02, with the exception that results are reported in English units. The test method covers the measurement of steady state thermal transmission through flat specimens using a heat flow meter apparatus. This is a comparative method of measurement and must be calibrated to specimen traceable to a recognized National Standards Laboratory. The apparatus was calibrated with standard Reference Material 1450c dated March 5, 1997 supplied by the National Institute of Standards and Technology.

#### Specimen/Project Description:

Series/Model: Insul-Tarp Slab Configuration DRFB.5

Configuration: Four inch concrete slab, 1/2" insulation, 2" gravel/rock, 1" sand

#### Testing Conditions:

The specimen had 7/16" plywood bottom, with an R-Value of 0.372.  
This R-Value was subtracted from total product R-Value.

Cold plate temperature: 55°F nominal  
Warm plate temperature: 75°F nominal  
Mean plate temperature: 65.0°F nominal  
Vertical heat flow (Down): Horizontal specimen  
Specimen average thickness: 8.0"  
Specimen average density: 78.75 lbs/ft<sup>3</sup>  
Average thermal resistance (R): 7.54 hr·ft<sup>2</sup>·°F/Btu  
Average thermal resistance (Rsi): 1.33 m<sup>2</sup>·K/W



# INSUL-TARP®

## Case Study

### Insul-Tarp® Case Study Evaluation 2 Wisconsin Facilities

#### Description

The following case study compares two facilities of similar size and construction. The only difference is, Pat's Heating shop has a 1" rigid foam insulation board below the slab while Able Distributing Headquarters has the Insul-Tarp® insulation blanket below the slab. As you can see, although the building sizes are different (Able's is almost twice as large as Pat's), the Able building had significantly lower heating cost per sq. foot of building space. This is significant considering Able's had a set point of 70° F vs. 60° F in Pat's. Able Distributing also is located in a colder climate as indicated by the outdoor design temp.

#### Case Study Results

FACILITY	PAT's Heating Shop Oconomowoc, WI	ABLE Distributing Headquarters Wausau, WI
<b>DESIGN PARAMETERS</b>		
Ceiling Insulation	R-19	R-19
Wall Insulation	R-13	R-13
Floor Area (Sq. Ft.)	8,000	15,000
Indoor Design Temp. (°F)	60° F	70° F
Outdoor Design Temp. (°F)	-10° F	-20° F
Floor Construction	6" slab on grade (w/ 1" rigid insul. Board)	6" slab on grade (w/ Insul-Tarp)
Infiltration (air changes/hr)	0.33	0.33
<b>ACTUAL HEATING COSTS</b>		
December 2000	\$824.67 (\$ .1031/sf)	\$939.28 (\$ .0626/sf)
<b>Monthly Savings per Sq. Ft.</b>		<b>\$ .0405/s.f./month</b>
<b>Insul-Tarp Energy Savings over 1" Rigid Insulation:</b>		<b>39.3 % *</b>

\*Adjustments for Indoor and Outdoor Design Temperature

Anticipated savings are expected to be even greater due to the differences in indoor design temperature and outdoor design temperatures. Wausau has a December average monthly low temperature of 2° to 3° F below Oconomowoc. If adjustments were made to actual temperatures during the Case Study evaluations, and adjustments were made for the indoor setpoint temperatures, larger savings would result than the actual data shown above.

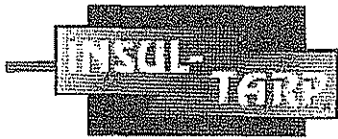

# INSUL-TARP®

Case Study

Insul-Tarp® Case Study Evaluation  
2 Wisconsin Facilities

## Insul-Tarp vs. FoamBoard

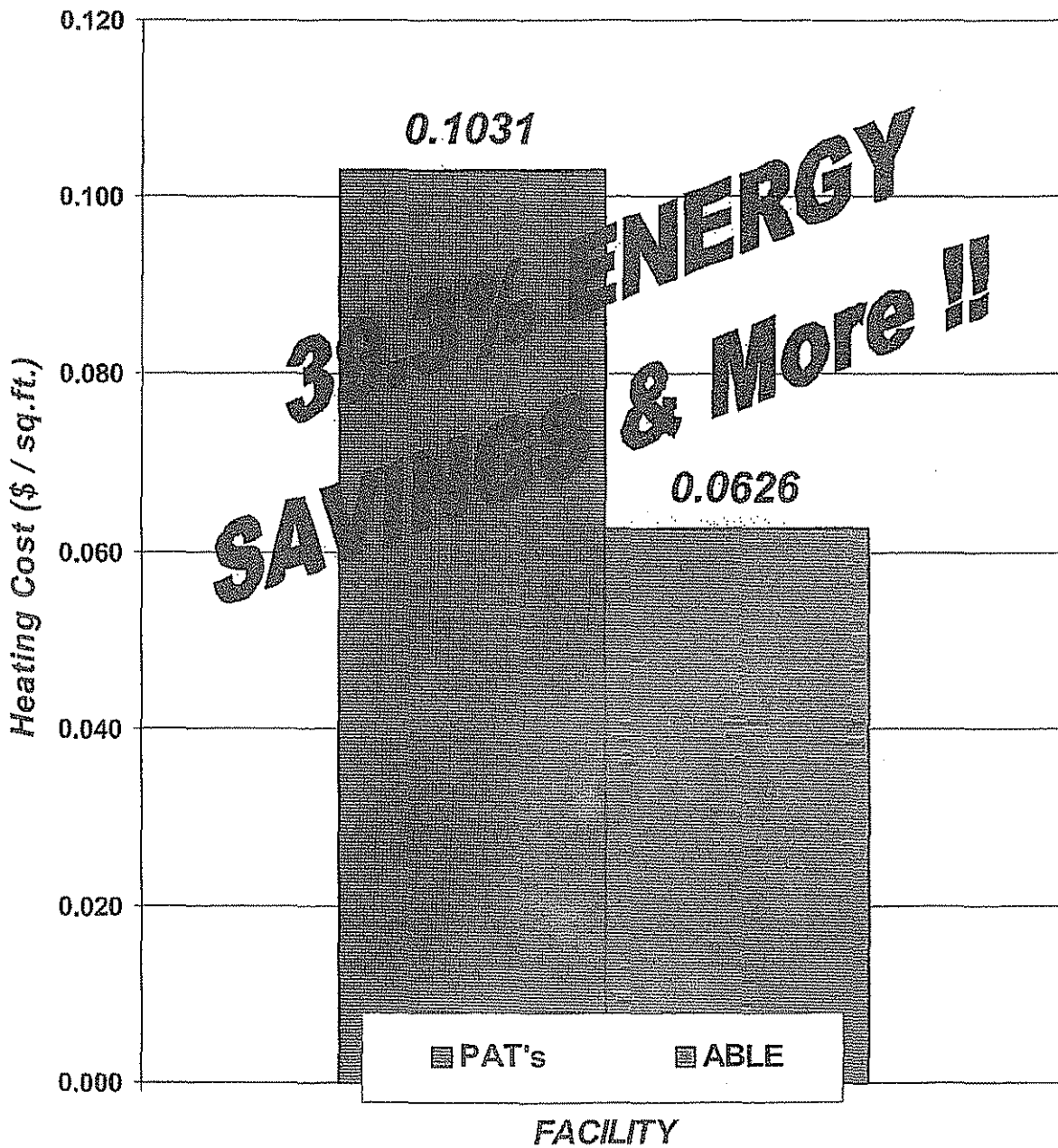

Ex. 3 page 21

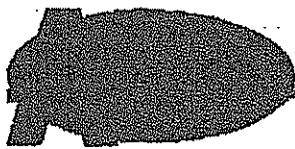

ABLE DISTRIBUTING CO., INC.   
 401 South 4th Street  
 P.O. Box 1387  
 Wausau, WI 54402-1387  
 Phone: (715) 842-2258  
 FAX: (715) 848-8289

**Rohde Builders**  
**6400 Gisholt Drive**  
**Madison, WI 53713**

ABLE DISTRIBUTING CO., INC.   
 3009 North Zuni Drive  
 Appleton, WI 54911  
 Phone: (920) 830-2579  
 FAX: (920) 830-2300

*Dave;*

ABLE DISTRIBUTING CO., INC.   
 2727 West Grand Avenue  
 Phoenix, AZ 85015  
 Phone: (602) 993-1140  
 FAX: (602) 942-8801

*The best comparison between two similar buildings heated with Insul Turp vs rigid foam insulation, are the projects I mentioned to you yesterday. Pat's Heating of Oconomowoc, was a project that was of identical building construction and insulation factors as a slightly larger building we did at our Able Distributing headquarters in Wausau. Both buildings had R13 wall and R19 ceiling insulation, were of identical block and steel construction, with 24' average ceiling heights. The only design difference was that Pat's Heating shop area was designed at 60 degrees Fahrenheit, while the entire Able shop/offices were designed at 70 degrees. Additionally, both buildings were heated with high-efficiency, PVC vented condensing boilers (90% + AFUE).*

ABLE DISTRIBUTING CO., INC.   
 6225 North Colorado Street  
 Chandler, AZ 85225-1151  
 Phone: (480) 545-1293  
 FAX: (480) 545-8352

ABLE DISTRIBUTING CO., INC.   
 204 East Mayflower  
 North Las Vegas, NV 89030  
 Phone: (702) 649-2880  
 FAX: (702) 649-2884

*Although the two structures were built in different parts of the State, we can simulate precisely the projected energy consumption of each building by changing the outdoor design temperature to match the location of the structure. As you can see, if the Able building were located in Oconomowoc instead of Wausau, it would cost 11% less to heat, based on the decrease in BTU consumption as indicated by the different outdoor design temperatures.*

ABLE DISTRIBUTING CO., INC.   
 4000 East Columbia Street  
 Tucson, AZ 85714  
 Phone: (520) 780-7608  
 FAX: (520) 780-1012

*Actual December, 2000 heating bills for the two buildings were as follows:*

ABLE DISTRIBUTING CO., INC.   
 3535 North First Avenue  
 Tucson, AZ 85718  
 Phone: (520) 887-8888  
 FAX: (520) 252-4412

*Pats Heating: \$324.67 or .1031/SF*  
*Able Shop: \$939.28 or .0626/SF*

ABLE TECHNOLOGY, LLC   
 401 South 4th Street  
 P.O. Box 1387  
 Wausau, WI 54402-1387  
 Phone: (715) 842-2258  
 FAX: (715) 848-8289

ABLE FIELD SERVICES   
 401 South 4th Street  
 P.O. Box 1387  
 Wausau, WI 54402-1387  
 Phone: (715) 842-2258  
 FAX: (715) 848-8289



ABLE DISTRIBUTING CO., INC.   
401 South 4th Street  
P.O. Box 1387  
Wausau, WI 54402-1387  
Phone: (715) 843-2255  
FAX: (715) 843-2255

ABLE DISTRIBUTING CO., INC.   
2019 North Zuniwa Drive  
Appleton, WI 54911  
Phone: (920) 820-2375  
FAX: (920) 820-2300

ABLE DISTRIBUTING CO., INC.   
2727 West Groves Avenue  
Phoenix, AZ 85023  
Phone: (602) 853-1140  
FAX: (602) 842-3451

ABLE DISTRIBUTING CO., INC.   
3225 North Colorado Street  
Chandler, AZ 85225-1101  
Phone: (480) 845-1285  
FAX: (480) 845-2252

ABLE DISTRIBUTING CO., INC.   
204 East Mayflower  
North Las Vegas, NV 89030  
Phone: (702) 849-0883  
FAX: (702) 849-2834

ABLE DISTRIBUTING CO., INC.   
4700 East Columbia Street  
Tucson, AZ 85714  
Phone: (520) 780-7000  
FAX: (520) 780-1002

ABLE DISTRIBUTING CO., INC.   
5535 North First Avenue  
Tucson, AZ 85710  
Phone: (520) 887-8200  
FAX: (520) 283-4412

ABLE TECHNOLOGY, LLC   
401 South 4th Street  
P.O. Box 1387  
Wausau, WI 54402-1387  
Phone: (715) 843-2255  
FAX: (715) 843-2255

ABLE FIELD SERVICES   
401 South 4th Street  
P.O. Box 1387  
Wausau, WI 54402-1387  
Phone: (715) 843-2255  
FAX: (715) 843-2255

*Because of the direct correlation between BTU load and energy consumption, we can accurately interpolate the Able heating bill to the design parameters of the Pat's Htg building. Using the indicated 11% decrease in BTU consumption, would project an actual cost per square foot of .05572/SF to heat the Able building if it were located in the same design area as Pat's Heating. This would indicate that using InSul Tarp instead of 1" 250-density, rigid insulation would result in an energy consumption savings of 46%! This reflects InSul Tarp's claim that radiant transmission of heat from a slab is the greatest single source of heat loss in this type of application, and a factor that traditional rigid foam insulation cannot address.*

Thank You,

**Dave Viegut**  
**General Manager**  
**Heating Division**  
**Able Distributing Company**



# Heat Loss Analysis Report

WIRSBO Radiant Panel Heating System

Project #: DV9-7-00-1

Date: 8/7/2000

## Prepared By

Able Distributing Co.  
401 So. 4th St.  
Wausau, WI 54402-1897

Phone #: (715) 842-2256  
Fax #: (715) 848-8289  
By: Dave Viegut

## Project Information

Name: Able Tech Fab Shop  
Location: Wausau, WI  
Closing Date:

Owner: Able Distributing Co.  
Engineer: Dave Viegut

## Project Summary

**Total Heat Loss:**  
 Floor Downward: 24,341 Btu/hr  
 Ceiling Upward: 63,168 Btu/hr  
 Other Components: 265,865 Btu/hr  
 Supplemental: (0) Btu/hr  
 Total RPH Load: 353,364 Btu/hr  
  
 Total Combined Load: 353,364 Btu/hr  
 (including Supplemental)

Total Area: 15,000 sq ft  
 Outdoor Temp: -10 °F

*Simulated  
 Occupied w/oc Construction*

Rooms Requiring Supplemental: None (11% decrease)

## Detailed Heat Loss Data

### Room : Fab Shop

Gross Area: 15,000 sq ft  
 Ceiling Height: 24 ft  
 Volume: 360,000 cu ft  
 Perimeter Length: 0 ft  
  
 Air Changes: 0.33 per Hour  
 Room Temp: 70 °F  
 Room Infiltration: 163,177 Btu/hr

**Total Heat Loss:**  
 Floor Downward: 24,341 Btu/hr  
 Ceiling Upward: 63,168 Btu/hr  
 Other Components: 265,865 Btu/hr  
 Supplemental: (0) Btu/hr  
 Net RPH Load: 353,364 Btu/hr  
**Unit RPH Heat Loss:**  
 Floor: 23.8 Btu/hr/sq ft  
 Ceiling: N/A

### Floor Component

Floor Area: 15,000 sq ft  
 Unheated Area: 0 sq ft  
 Net Heated Area: 15,000 sq ft  
 Floor Type: Slab On Grade  
 Floor Cover Rv: 0.00  
 Under Slab Rv: 10.00  
 Edge Rv: 10.00  
 Perimeter Rv: 10.00  
 Temp Below: 70 °F  
 Slab Depth: 6 inches

Water Table Present: No  
 Space Below Heated: N/A  
 Floor Surface Temp: 60.9 °F  
**Heat Loss:**  
 Downward Loss: 24,341 Btu/hr  
 Upward Loss: 329,023 Btu/hr  
 Supplemental: (0) Btu/hr  
 Net Floor Load: 353,364 Btu/hr  
 Unit Heat Load: 23.8 Btu/hr/sq ft

Created using Radiant Express Version 4.0



# Heat Loss Analysis Report

## WIRSEBO Radiant Panel Heating System

Project #: DV8-7-08-1  
Date: 11/7/2008

### Prepared By

Able Distributing Co.  
401 So. 4th St.  
Wausau, WI 54402-1267

Phone #: (715) 842-2255  
Fax #: (715) 848-8250  
By: Dave Visgut

### Project Information

Name: Able Tech Fab Shop  
Location: Wausau, WI  
Closing Date:

Owner: Able Distributing Co.  
Engineer: Dave Visgut

### Project Summary

**Total Heat Loss:**  
 Floor Downward: 25,884 Btu/hr  
 Ceiling Upward: 71,053 Btu/hr  
 Other Components: 200,000 Btu/hr  
 Supplemental: (0) Btu/hr  
 Total RPH Load: 387,015 Btu/hr  
  
 Total Combined Load:  
 (including Supplemental) 387,015 Btu/hr

Total Area:  
Outdoor Temp:

16,000 sq ft  
-20 °F

Wausau  
Construction

Rooms Requiring Supplemental: None

### Detailed Heat Loss Data

#### Room : Fab Shop

Gross Area: 16,000 sq ft  
 Ceiling Height: 24 ft  
 Volume: 380,000 cu ft  
 Perimeter Length: 600 ft  
  
 Air Changes: 0.22 per Hour  
 Room Temp: 70 °F  
 Room Infiltration: 200,074 Btu/hr

**Total Heat Loss:**  
 Floor Downward: 25,884 Btu/hr  
 Ceiling Upward: 71,053 Btu/hr  
 Other Components: 200,000 Btu/hr  
 Supplemental: (0) Btu/hr  
 Net RPH Load: 387,015 Btu/hr  
 Unit RPH Heat Load:  
 Floor: 25.6 Btu/hr/sq ft  
 Ceiling: N/A

#### Floor Component

Floor Area: 16,000 sq ft  
 Unheated Area: 0 sq ft  
 Net Heated Area: 16,000 sq ft  
 Floor Type: Slab On Grade  
 Floor Cover Rv: 0.00  
 Under Slab Rv: 10.00  
 Edge Rv: 10.00  
 Perimeter Rv: 10.00  
 Temp Below: 70 °F  
 Slab Depth: 6 inches

Water Table Present: No  
 Space Betw Heated: N/A  
 Floor Surface Temp: 62.9 °F  
**Heat Loss:**  
 Downward Loss: 25,884 Btu/hr  
 Upward Loss: 370,151 Btu/hr  
 Supplemental: (0) Btu/hr  
 Net Floor Load: 387,015 Btu/hr  
 Unit Heat Load: 25.6 Btu/hr/sq ft

Created using Radiant Express Version 4.6



MBA Corporation  
 4388 South Kansas  
 Milwaukee, WI 53235

Attention Mark Krumnow

Mark;

Here are the utility expenses for the Pat's Heating apartment projects I spoke to you about. The two buildings are located within 3 miles of each other, were built by the same construction company using the same construction methods and materials, and were insulated to the same specifications with the exception of the underslab insulation. Both projects were heated by 92% AFUE boilers. The only difference in construction methods was that Project #1 used 2" rigid foam, and was a 9600sf 8 family, while Project #2 was a 19200sf 16 family and was insulated with InSul Tarp. Both projects used 2" foam edge insulation. Following are the utility bills for January, February and March of 2005 for both projects. I've noted the cost per square foot to heat each building.

	Building #1	Building #2
Jan	\$517.48 (.054/sf)	\$596.62 (.031/sf)
Feb	\$414.44 (.043/sf)	\$601.63 (.031/sf)
March	<u>\$558.95 (.058/sf)</u>	<u>\$625.87 (.032/sf)</u>
Avg	\$496.96 (.052/sf)	\$608.04 (.0315/sf)

While there may be some slight differences in heat loss on the two buildings because of exposure, wind direction and infiltration, the two buildings should be considered a good test of the differences between standard rigid foam insulation and InSul Tarp. By my calculations Building #2 insulated with InSul Tarp consistently came in about 39% less cost to heat than Building #1.

Dave Viegut

Hydronic Heating Manager  
 Auer Steel of Wisconsin

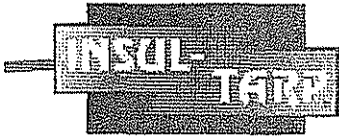

# INSUL-TARP®

## Lab Test Evaluation 1

### Insul-Tarp® Lab Test Evaluation 1 Insul-Tarp® vs. Bubble-Foil-Bubble vs. No Insulation

**Description**

Three tests were conducted to evaluate the effectiveness of Insul-Tarp® versus another product called Bubble-foil-bubble and also against no insulation. The test consists of a large plastic container 18" deep x 18" wide and 36" long (See figure 1). Temperature thermocouples were inserted into the limestone just beneath the slab and one near the outer surface of the bottom of the container. Continuous heat was applied to the top of the slab while readings from the thermocouples were taken over a period of time. The results of this test are shown in Figure 2. The graph shows the difference in temperature between the upper and lower thermocouple. As you can see after approximately 12 hours, the temperature difference stabilized with the Insul-Tarp® with approximately a 150% increase in the differential as compared to the "No Insulation" test.

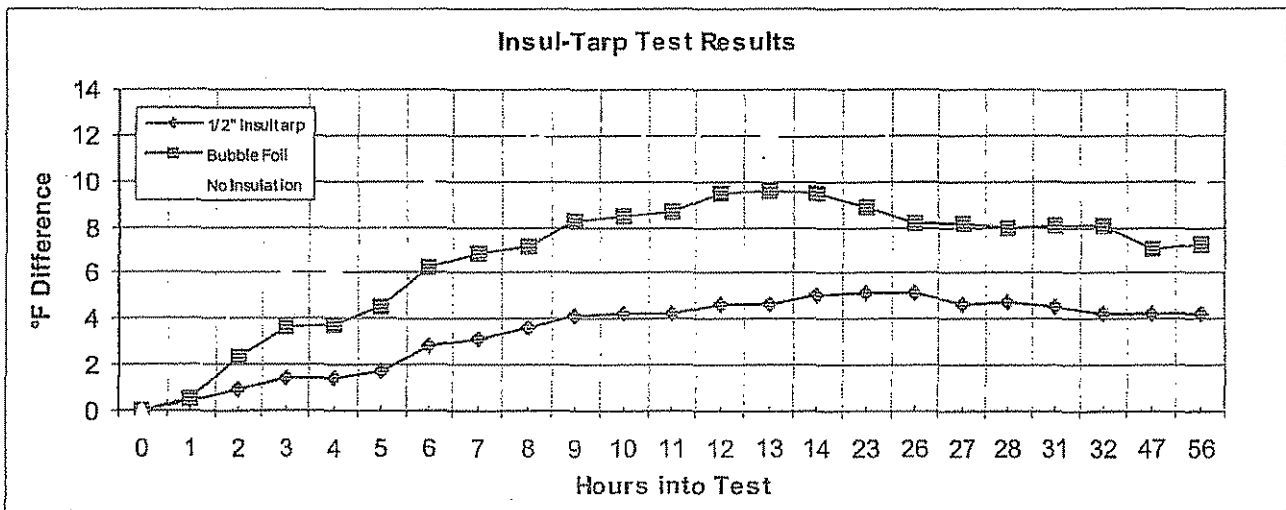

**Lab Test Results**

TEST	Avg. °F Difference *	Temp. Differential Increase
Insul-Tarp Insulation	4.580	0%
Bubble-Foil-Bubble	8.430	84%
No Insulation	11.380	148%
* After Stabilization		

**Conclusions:**

Because temperature differential has a linear relationship with heat loss, it is easy to see how the low differential temperature in the 8" of limestone beneath the slab and the Insul-Tarp® helps reduce heat loss through the slab to the limestone bedding below. The bubble-foil has a temperature differential nearly twice that of the Insul-Tarp® and the No insulation test has a factor of 2.5 times the differential indicating a significantly larger heat loss characteristic than that of Insul-Tarp®.



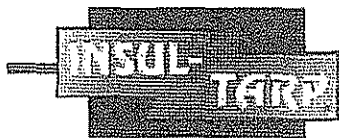

# INSUL-TARP®

Lab Test Evaluation 1

Insul-Tarp® Lab Test Evaluation 1  
Insul-Tarp® vs. Bubble-Foil-Bubble vs. No Insulation

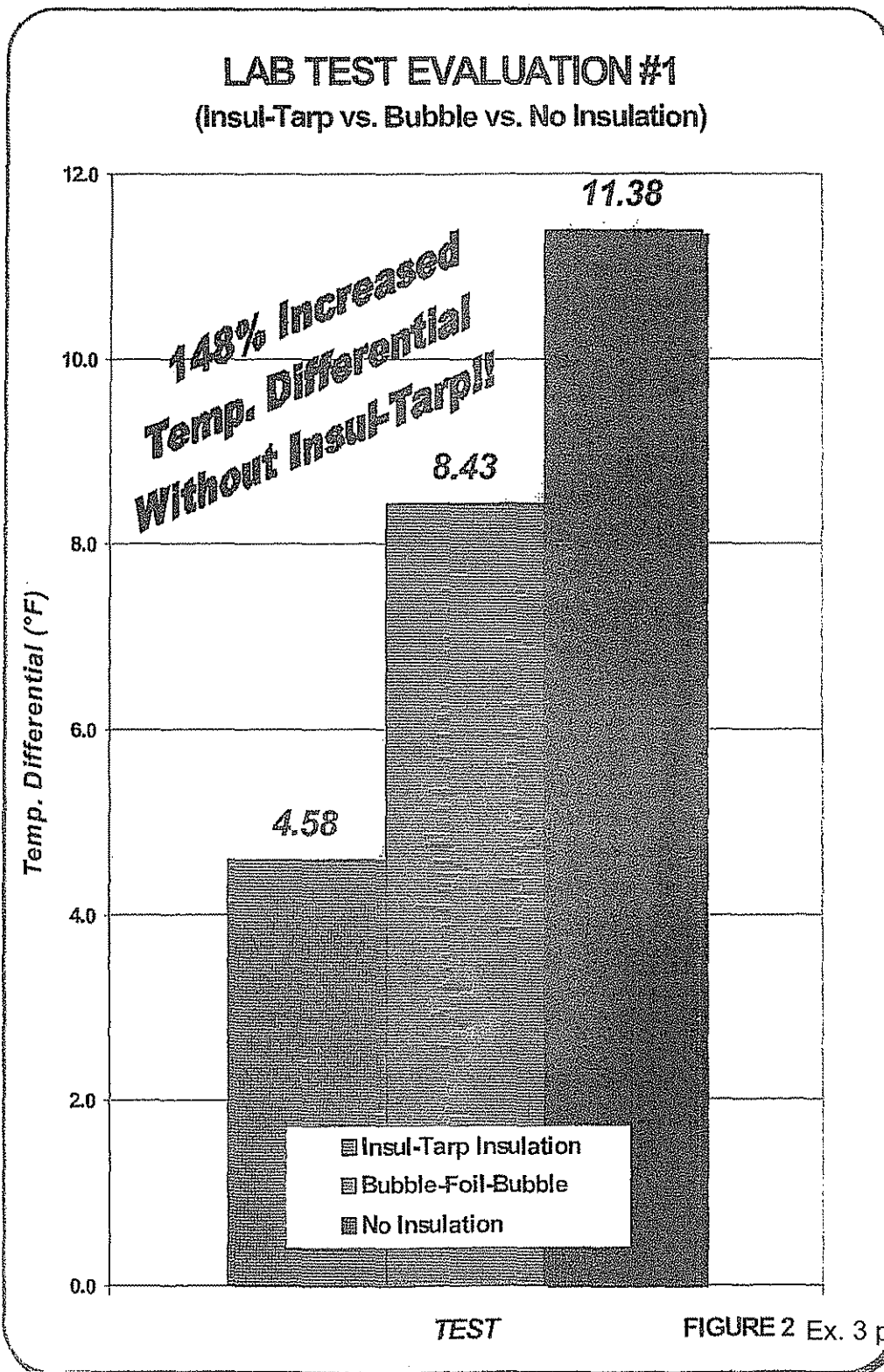
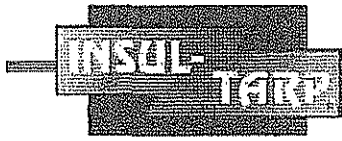

FIGURE 2 Ex. 3 page 28



# INSUL-TARP®

## Lab Test Evaluation 2

### Insul-Tarp® Lab Test Evaluation 2 Insul-Tarp® vs. No Insulation

#### Description

The objective of this study is to compare the performance of an insulated concrete slab and an un-insulated concrete slab, to monitor the temperature increase of the slab in comparison with the room temperature. Two slab assemblies are considered for this study: One with No insulation under the slab, and one with Insul-Tarp® insulation below the slab. Temperature readings were measured near the center of each slab at several locations, readings were then taken over an 8-hour period, monitoring the indoor temperature and the temperature of both portions of the slabs. The results are presented below.

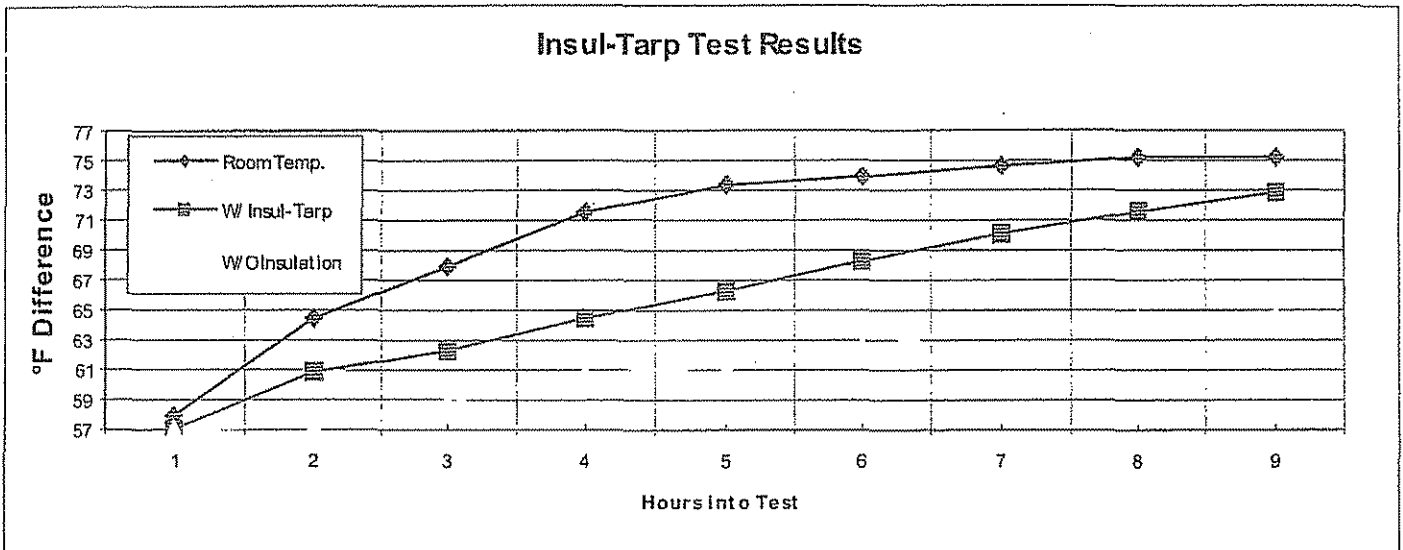

Figure 1

#### Lab Test Results

TEST	Avg. °F Difference Between Room and Center of Slab *
Insul-Tarp Insulation	2.30
No Insulation	10.60

\* After 8 Hours

#### Conclusions:

With the Insul-Tarp® insulation system installed under the slab, the temperature of the concrete will increase with the room temperature as shown by the reduced temperature differential between the slab and the room temperature. The heat will be retained in the concrete longer which means two advantages, reduced heating costs and more comfortable floor surface temperatures.

# INSUL-TARP®

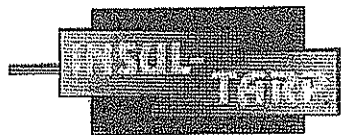

## Lab Test Evaluation 2

Insul-Tarp® Lab Test Evaluation 2  
 Insul-Tarp® vs. No Insulation

Room Temp.	W/Insul-Tarp	W/O Insulation
58	57	57
64.4	60.8	57.2
68	62.3	58.9
71.6	64.4	60.8
73.4	66.2	61.2
74	68.3	62.7
74.6	70.1	63.8
75.2	71.6	64.4
75.2	72.9	64.6
	2.3	10.6
		361%

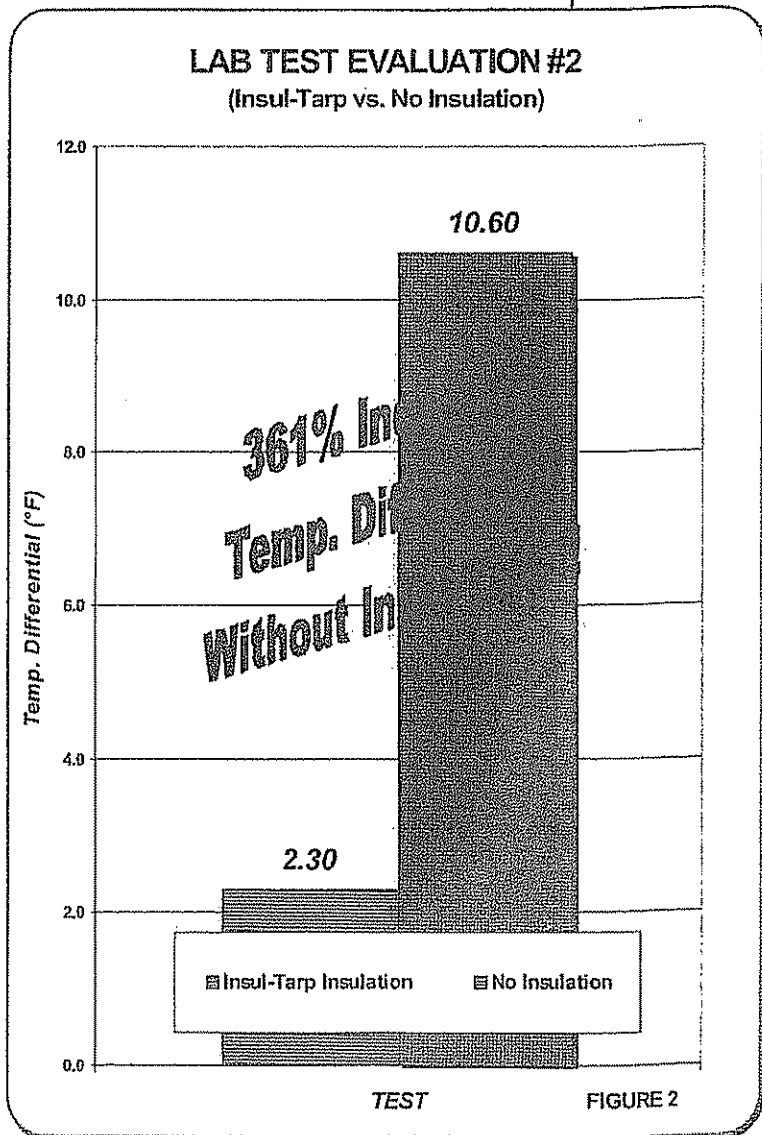

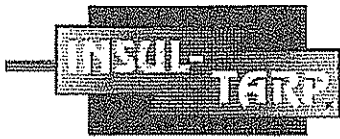

# INSUL-TARP®

## Lab Test Evaluation 3

### Insul-Tarp® Lab Test Evaluation 3 Insul-Tarp® vs. Bubble-Foil-Bubble vs. 2" Foam Board R-10

#### Description

Three tests were conducted to evaluate the effectiveness of Insul-Tarp® vs. 2 other insulation materials, 3/8" Bubble-Foil-Bubble insulation and 2" Foam Board insulation. The tests were conducted using (3) 11" x 13" test boxes. The test boxes were built using ceramic tile (3/8"), sand, insulation and Raytec-Heat Blanket. Each test box was started at approximately 80° F, then allowed to operate for 60 minutes. The temperature thermocouple was located directly on the ceramic tile surface, measuring the actual surface temperature of the floor material.

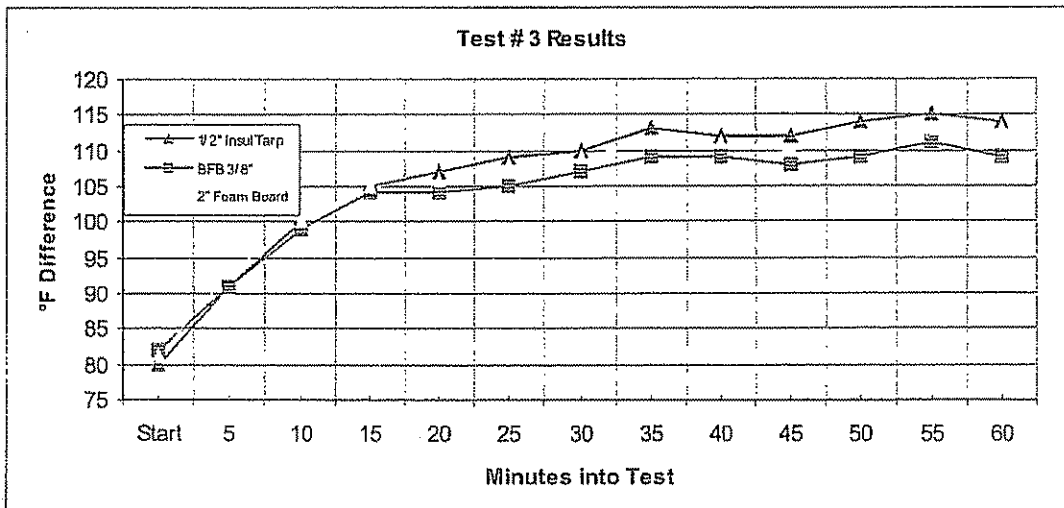

#### Lab Test Results

TEST	Avg. °F Surface Temp. *	Advantage of Insul-tarp vs. Foam Board
Insul-Tarp Insulation	112.86	61.9% Warmer when comparing both to Bubble-Foil-Bubble
Bubble-Foil-Bubble	108.36	
2" Foam Board	111.14	

\* After 30 minutes stabilization period.

#### Conclusions:

Upon stabilization of the test box (~30 minutes) the Insul-Tarp® insulation blanket provides a warmer surface temperature than either the bubble-foil-bubble or the 2" Foam Board. This will increase comfort of the space as well as reduce energy costs. When comparing the surface temperature of the Insul-Tarp® to the Foam Board against the Bubble-Foil-Bubble temperature, Insul-Tarp® Insulation provides a 61.9% warmer surface temperature than Foam Board.



# INSUL-TARP®

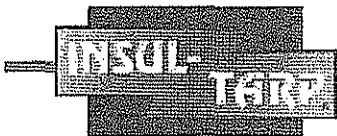

## Lab Test Evaluation 3

### Insul-Tarp® Lab Test Evaluation 3 Insul-Tarp® vs. Bubble-Foil-Bubble vs. 2" Foam Board

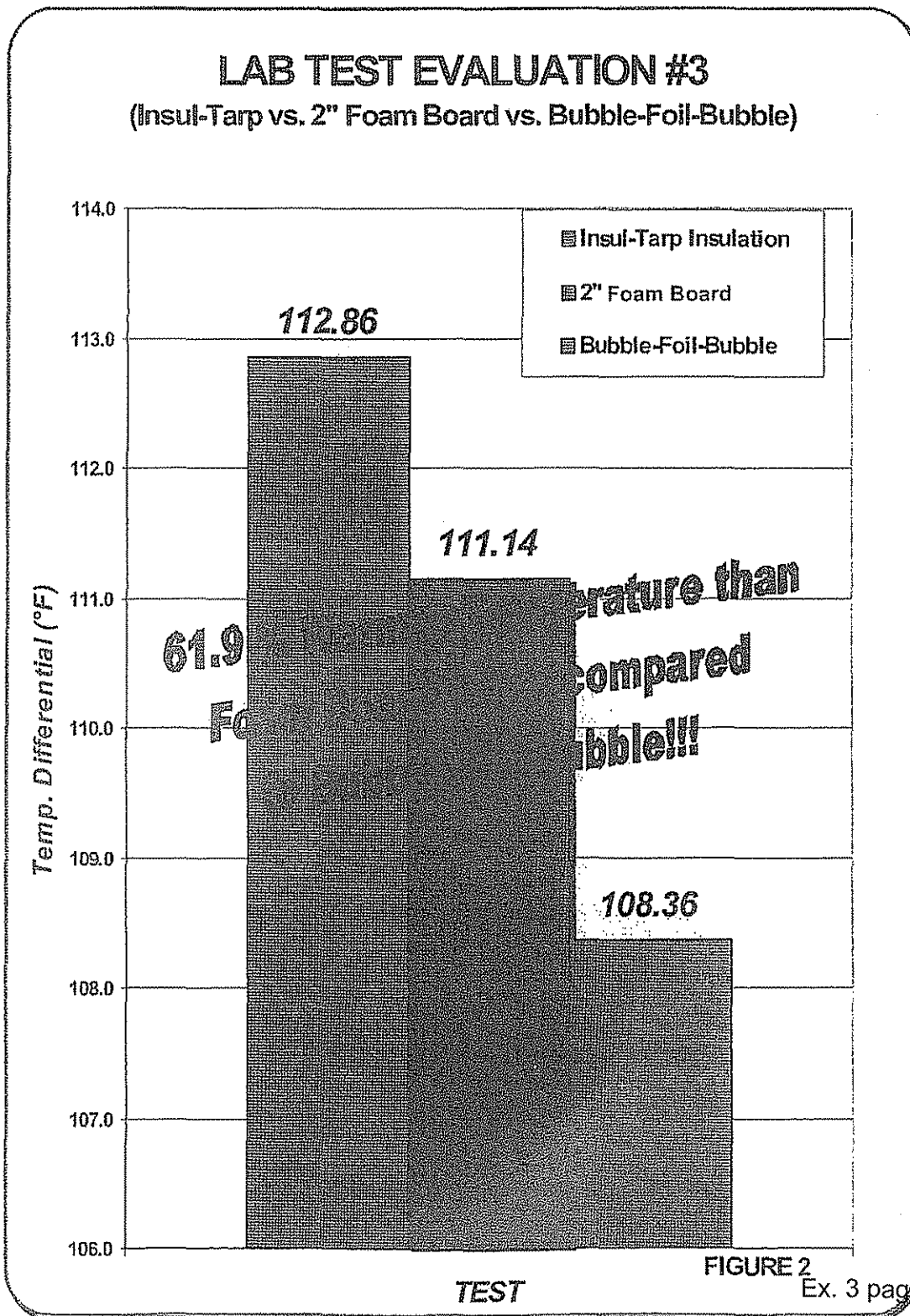

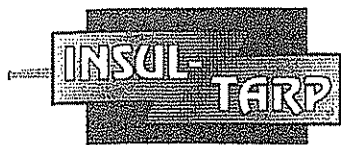

# INSUL-TARP

## USDL Material Safety Data Sheet

### Material Safety Data Sheet

USDL Safety and Health Regulations OSHA Hazard Communication Standard

#### SECTION 1: PRODUCT IDENTIFICATION

NAME: Insul-Tarp®

DESCRIPTION: Cross Woven Polyethylene/Micro Foam Closed Cell/Cross Woven Polyethylene

PRIMARY: Insulation Solutions, Inc.

ADDRESS: 401 Truck Haven Road  
East Peoria, IL 61611

TELEPHONE: (309) 698-0062

FAX: (309) 698-0065

#### SECTION 2: HAZARDOUS INGREDIENTS

This product is not considered to be hazardous, and is not classified as a controlled product. It comprises principally of polyethylene and micro cell foam, which are non-hazardous.

#### SECTION 3: PHYSICAL DATA

BOILING POINT: Not Applicable

TEMPERATURE RANGE: -60°F to 180°F

APPEARANCE: Flexible Sheet

ODOR: None

SOLUBILITY IN WATER: Insoluble Bulk Weight

#### SECTION 4: FIRE & EXPLOSION DATA

FLAME SPREAD: 10 When Applied

SMOKE DEVELOPMENT: 15 When Applied

EXTINGUISHING MEDIA: Mist Spray, Dry Chemical, Water Fog, Foam, CO<sup>2</sup>

#### SPECIAL FIRE FIGHTING PROCEDURES

Self-contained breathing apparatus and protective clothing should be worn in fighting any fire.

#### UNUSUAL FIRE EXPLOSION HAZARDS

None



# INSUL-TARP

## OSHA Material Safety Data Sheet

### SECTION 5: REACTIVITY DATA

**STABILITY:** Insul-Tarp® is stable and inert to most chemicals. Does not cause a violent reaction.

**INCOMPATIBILITY:** Consult Insulation Solutions, Inc. prior to using as a containment or barrier for chemicals other than water.

**HAZARDOUS POLYMERIZATION:** Will not occur.

### SECTION 6: HEALTH HAZARD DATA

**THRESHOLD LIMIT VALUE:** Not Established

**EFFECTS OF OVEREXPOSURE:** None Expected

**INHALATION:** None Expected

**EYES & SKIN:** None Expected

**INGESTION:** Insul-Tarp® should not be eaten or kept in contact with food.

### SECTION 7: FIRST AID PROCEDURES

**EMERGENCY FIRST AID PROCEDURES:** If burned by contact with hot plastic, cool and moisten material adhering to skin as quickly as possible with cold water. See physician for removal and treatment of burn.  
DO NOT USE SOLVENTS OR THINNER TO DISSOLVE.

### SECTION 8: SPILL OR LEAK PROCEDURES

**WASTE DISPOSAL METHOD:** Dispose of in accordance with local regulations

### SECTION 9: SPECIAL PROTECTION INFORMATION

Generally, Insul-Tarp® requires no special precaution when handling. However, the product may be slippery when wet, therefore when walking on it care should be taken.

**RESPIRATORY PROTECTION:** None Required

**VENTILATION:** Local Ventilation

**PROTECTIVE GLOVES:** None Required

**EYE PROTECTION:** None Required

### SECTION 10: SPECIAL PRECAUTIONS

Precautions to be taken in handling and storing: Keep away from extreme heat.

### USE GOOD PLANT & FIELD PRACTICES

**NOTE:** THE INFORMATION CONTAINED IN THIS SHEET IS DISCLOSED IN GOOD FAITH AND IS PROVIDED TO THE BEST KNOWLEDGE OF INSULATION SOLUTIONS. IT IS NOT A WARRANTY AND INSULATION SOLUTIONS ASSUMES NO RESPONSIBILITY FOR DAMAGES INCURRED FROM THE USE OR INABILITY TO USE THIS PRODUCT.

NOTES:

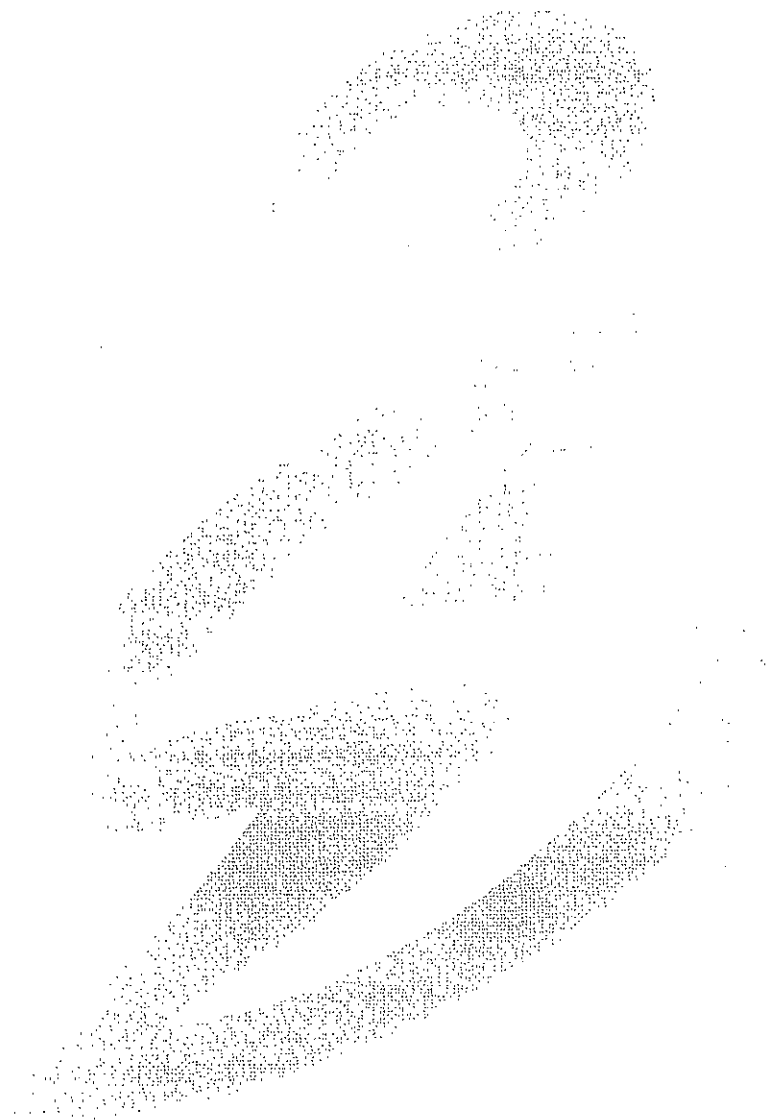



# EXHIBIT 4

*Insul-Tarp labeled on Product.*

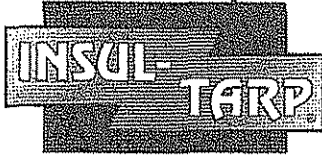

Patent Nos. 5,549,956  
5,780,367 5,855,978  
5,874,150 7,000,359

Tested in Accordance to ASTM C518, ASTM E96, ASTM D412-98, ASTM D751-00,  
ASTM D3575-00, ASTM E1643-98  
MEETS MOST ICC, IBC, SBCCI, HUD, BOCA, ICBO Requirements

**SYSTEM PERFORMANCE:**

Non-Radiant R-7.54 (Concrete Slab Assembly)

Radiant R-10 (Field and Lab Supported)

Temperature Range: -60°F to 180°F Perm Rate: .002 perms

TEST DATA AVAILABLE UPON REQUEST

CAUTION: *This product will ignite if exposed to fire of sufficient heat and intensity.  
Check local building codes prior to installation.*

For More Information Check With Your Local Distributor or [www.insulationsolutions.com](http://www.insulationsolutions.com)

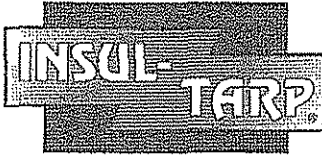

Patent Nos. 5,549,956  
5,780,367 5,855,978  
5,874,150 7,000,359

Tested in Accordance to ASTM C518, ASTM E96, ASTM D412-98, ASTM D751-00,  
ASTM D3575-00, ASTM E1643-98  
MEETS MOST ICC, IBC, SBCCI, HUD, BOCA, ICBO Requirements

**SYSTEM PERFORMANCE:**

Non-Radiant R-7.54 (Concrete Slab Assembly)

Radiant R-10 (Field and Lab Supported)

Temperature Range: -60°F to 180°F Perm Rate: .002 perms

TEST DATA AVAILABLE UPON REQUEST

CAUTION: *This product will ignite if exposed to fire of sufficient heat and intensity.  
Check local building codes prior to installation.*

For More Information Check With Your Local Distributor or [www.insulationsolutions.com](http://www.insulationsolutions.com)

*Handwritten signature*

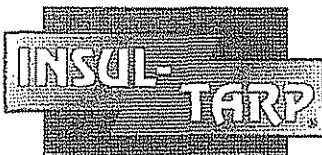

Patent Nos. 5,549,956  
5,780,367 5,855,978  
5,874,150 7,000,359

Tested in Accordance to ASTM C518, ASTM E96, ASTM D412-98, ASTM D751-00,  
ASTM D3575-00, ASTM E1643-98  
MEETS MOST ICC, IBC, SBCCI, HUD, BOCA, ICBO Requirements

**SYSTEM PERFORMANCE:**

Non-Radiant R-7.54 (Concrete Slab Assembly)

Radiant R-10 (Field and Lab Supported)

Temperature Range: -60°F to 180°F Perm Rate: .002 perms

TEST DATA AVAILABLE UPON REQUEST

CAUTION: *This product will ignite if exposed to fire of sufficient heat and intensity.  
Check local building codes prior to installation.*

For More Information Check With Your Local Distributor or [www.insulationsolutions.com](http://www.insulationsolutions.com)

# **EXHIBIT 5**



© Today is Mon, Jan 7th, 2008

[CONTACT US](#) | [REGISTER](#) | [TRADE SHOWS](#) | [SITE MAP](#)

[HOME](#) | [PRODUCTS](#) | [RESOURCES](#) | [NEWS ROOM](#) | [ABOUT US](#)

## INSUL-TARP

[BACK TO PRODUCTS](#)

[INFORMATION](#) · [TECHNICAL DATA](#) · [APPLICATIONS](#) · [TESTIMONIALS](#) · [INSTALLATION INSTRUCTIONS](#)



"The Industry's Premier Under-Slab Insulation!"

### MATERIALS & CONSTRUCTION:

Cross woven polyethylene, high density closed-cell foam, a layer of high density polyethylene bubble and two layers of reflective aluminum.

Thickness	3/4" (nominal)
Normal Weight	12.5 lbs. / 150 sq. ft.

### PHYSICAL PROPERTIES:

Property	Test Method	Insul-Tarp®
Average Thermal Resistance	ASTM C 518	R - 7.5
Tensile Strength and Elongation*	ASTM D 412	136 PSI
Tensile Strength**	ASTM D 751	45 lbf/in.
Compression Set	ASTM D 3575	4.3 %
Bursting Strength*	ASTM D-751-73	90 PSI
Maximum Use Temperature		180° F
Minimum Use Temperature		-60° F
Water Vapor Permeance	ASTM E 96	.002 Perms

\* denotes testing on bubble pack only

\*\* denotes testing on cross woven polyethylene only

### ARCHITECTURAL & ENGINEERING SPECIFICATION:

Insul-Tarp® may be specified in construction specifications using the following division according to the Master Specification format.

Division 7 - Thermal Moisture Protection

- Section 07210 - Building Insulation
- Section 07240 - Exterior Insulation and Finished Systems

[Insul-Tarp® Specification Information](#)

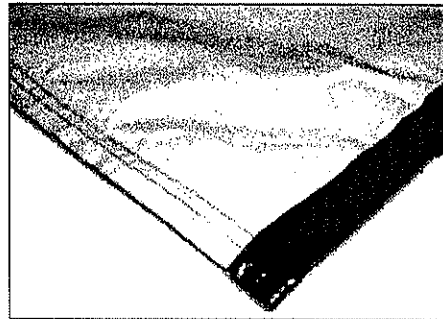

### THERMAL RESISTANCE (R-VALUE):

Tested R-Value :  
**R-7.5**

Insul-Tarp® was tested in accordance with ASTM C 518, *Standard Test Method for Steady-State Heat Flux Measurements and Thermal Transmission Properties by Means of the Heat Flow Meter Apparatus*. The following PDF summarizes the testing procedure and results:

[Insul-Tarp® Test Data Sheet](#)

### Performance Equivalent:

**R-10** (Under Radiant Heating Systems)

When calculating heat loads for radiant heating systems, a performance equivalent of R-10 can be used. Although this is not a tested R-value, field and laboratory tests support this number as a reasonable gauge of performance. The following PDF's illustrate Insul-Tarp®'s radiant heating performance:

[Insul-Tarp® Lab Test 1](#)

[Insul-Tarp® Lab Test 2](#)

[Insul-Tarp® Testimonial 1](#)

[Insul-Tarp® Testimonial 2](#)

040



# SPECIFICATION INFORMATION



**Division: 0700**

Revision #1

**1.0 Product Name**

**Insul-Tarp®**  
Under-Slab Insulation/Vapor Barrier.

**2.0 Manufacturer**

**Insulation Solutions®**  
Insulation Solutions Inc.  
401 Truck Haven Road.  
East Peoria, IL 61611

Engineering Assistance  
Toll Free: 866-698-6562  
Fax: 309-698-0065  
www.insulationsolutions.com

**3.0 Product Description**

**3.1 Basic Use:**

**Insul-Tarp®** is an under-slab insulation/vapor barrier designed to provide a thermal break and moisture barrier between the slab and grade. When used with radiant heated slab applications, **Insul-Tarp®** will increase the performance of the system by reflecting heat back into the slab.

**Insul-Tarp®** can also reduce condensation, mold and degradation by controlling water vapor migration.

**3.2 Composition & Materials:**

**Insul-Tarp®** is a half-inch, multilayer insulation. **Insul-Tarp®** is manufactured using cross woven polyethylene, high density closed-cell foam, a layer of high density polyethylene bubble and two layers of reflective aluminum. These layers combine to provide consistent thermal and moisture protection.

**3.3 Size:**

**Insul-Tarp®** is available in 6' X 25', 6' X 50', 12' X 25' and 12' X 50'. Estimate 10% overage as roll sizes are approximate.

**3.4 Weight:**

**Insul-Tarp®** weighs approximately 12.5 lbs. per 150 sq. ft.

**4.0 Technical Data**

**4.1 Applicable Standards**

American Society for Testing & Materials (ASTM)

- **ASTM C 518-02 Standard Test Method for Steady-State Thermal Transmission Properties by Means of the Heat Flow Meter Apparatus**
- **ASTM E 96 Standard Test Methods for Water Vapor Transmission of Materials**
- **ASTM E 1643 Standard Practice for Installation of Water Vapor Retarders Used in Contact with Earth or Granular Fill Under Concrete Slabs**
- **ASTM D 412-98 Standard Test Methods for Vulcanized Rubber and Thermoplastic Elastomers-Tension**
- **ASTM D 3575 Standard Test Methods for Flexible Cellular Materials Made From Olefin Polymers**
- **ASTM D 751 Standard Test Methods for Coated Fabrics**
- **ASTM D 1922 Standard Test Method for Propagation Tear Resistance of Plastic Film and Thin Sheeting by Pendulum Method**

*Note: To the best of our knowledge, these are typical property values and are intended as guides only, not as specification limits. Insulation Solutions Inc.® makes no warranties as to the fitness for a specific use or merchantability of products referred to, no guarantee of satisfactory results from reliance upon contained information or recommendations and disclaims all liability for resulting loss or damage.*

Test Results - Independent Test Facility		English
Thickness, Nominal		¾" (½" Compressed)
Weight Per 150 sq. ft.		12.5 lbs.
Average Thermal Resistance (System R-value)	ASTM C 518-02 (hr•ft²•°F/Btu)	R - 7.54* / R - 10.1**
Tensile Strength and Elongation (Bubble Pack)	ASTM D 412-98	136 psi
Tensile Strength (Cross Woven Polyethylene)	ASTM D 751 (Grab)	45 lbf/in.
Compression Set	ASTM D 3575-00	4.3%
Compression Set	ASTM D 3575-10-16	3.2%
Bursting Strength (Bubble Pack)	ASTM D 751-00 (Ball Burst)	95.1 lbf
Bursting Strength (Bubble Pack)	ASTM D 751-73 (Mullen)	90 psi
Tear Strength (Cross Woven Polyethylene)	ASTM D 1922 (Tongue Tear)	28 lbs (Warp) 33 lbs (Fill)
Maximum Use Temperature		180° F
Minimum Use Temperature		-60° F
Water Vapor Permeance	ASTM E 96	.002 perms CLASS A

\* R - 7.54 Non-Radiant Applications  
\*\* R - 10.1 Radiant Applications

#### 4.2 Environmental Considerations:

**Insul-Tarp®** can be used as a radon and methane gas barrier.

#### 4.3 Physical Properties

**Insul-Tarp®** conforms to the subsoil and will not crack or break when walked upon.

#### 5.0 Installation

##### INSUL-TARP® PLACEMENT

- 5.1 Level and tamp or roll granular base as specified by your architectural or structural drawings.
- 5.2 Unroll **Insul-Tarp®** with the longest dimension parallel with the direction of the pour.
- 5.3 Lap **Insul-Tarp®** over the footings and seal to the vertical foundation walls with appropriate tape. Seal around pipes, support columns or any other penetration by cutting an 'X' in the **Insul-Tarp®** and sliding it over the obstruction. Doing so will create a monolithic membrane between the surface of the slab and moisture sources below and at the slab perimeter.
- 5.4 Holes or openings through **Insul-Tarp®** should be effectively sealed with appropriate tape to maintain the integrity of the vapor barrier. Overlap joints a minimum of four inches. Seal overlap together with appropriate tape.

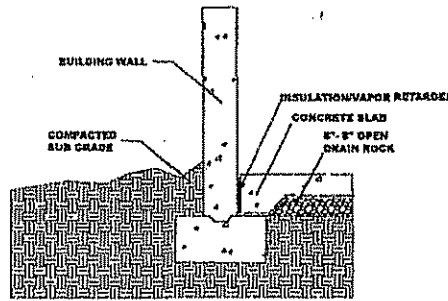

##### PROTECTION

- 5.5 When installing reinforcing steel and utilities in addition to the placement of concrete, take precaution to protect **Insul-Tarp®**. Carelessness during installation can damage the most puncture-resistant insulation/vapor barrier. Provide for additional protection in high-traffic areas.
- 5.6 Place standard reinforcing bar supports on **Insul-Tarp®**. The cross woven structure of **Insul-Tarp®** will help guard against possible punctures caused by reinforcing bar supports.
- 5.7 Avoid driving stakes through **Insul-Tarp®**. If this cannot be avoided, each individual hole must be repaired.
- 5.8 If a cushion or blotter layer is required in the design between the insulation/vapor barrier and the slab, additional care should be taken, especially if sharp crushed rock is used. Washed rock will provide less chance of damage during placement.

(These are very general installation instructions. Instructions on architectural or structural drawings should be reviewed and followed as well. ASTM E 1643 also provides valuable installation information).

#### 6.0 Availability & Cost

**Insul-Tarp®** is sold through construction and HVAC supply houses across the United States and Canada.

**Insul-Tarp®** current cost information can be obtained by calling our corporate sales office at 866-698-6562.

#### 7.0 Warranty

To the best of our knowledge, the specification chart on page one lists typical property values and are intended as guides only, not as specification limits. INSULATION SOLUTIONS INC. MAKES NO WARRANTIES AS TO THE FITNESS FOR A SPECIFIC USE OR MERCHANTABILITY OF PRODUCTS REFERRED TO, NO GUARANTEE OF SATISFACTORY RESULTS FROM RELIANCE UPON CONTAINED INFORMATION OR RECOMMENDATIONS AND DISCLAIMS ALL LIABILITY FOR RESULTING LOSS OR DAMAGE.

#### 8.0 Maintenance

If air pockets occur when pouring the concrete slab, simply cut a slit in the top layer of the tarp to release any trapped air. Place a piece of appropriate tape over the slit and continue pouring.

#### 9.0 Technical Services

Technical information and detailed test results can be obtained by calling our corporate office at 866-698-6562.

#### 10.0 Filing Systems

Additional information is available from the manufacturer.



# INSUL-TARP<sup>®</sup>

## Non-Radiant Test Data Sheet

### HEAT FLOW METER THERMAL TRANSMISSION TEST REPORT

Rendered To:

INSULATION SOLUTIONS, INC.  
401 Truck Haven Road  
East Peoria, IL 61611

**Project Summary:** Insulation Solutions<sup>®</sup> contracted a certified independent laboratory to conduct thermal conductance/conductivity testing on Insulation Solutions<sup>®</sup> Insul-Tarp<sup>®</sup> slab configuration DRFB.5.

The specimen was tested in accordance with ASTM C 518-02, *Standard Test Method for Steady-State Heat Flux Measurements and Thermal Transmission Properties by Means of the Heat Flow Meter Apparatus*. Test specimen description, data and results are reported herein.

**Test Method:** The test specimen was evaluated in accordance with the general requirements of ASTM C 518-02, with the exception that results are reported in English units. The test method covers the measurement of steady state thermal transmission through flat specimens using a heat flow meter apparatus. This is a comparative method of measurement and must be calibrated to specimen traceable to a recognized National Standards Laboratory. The apparatus was calibrated with standard Reference Material 1450c dated March 5, 1997 supplied by the National Institute of Standards and Technology.

#### Specimen/Project Description:

Series/Model: Insul-Tarp Slab Configuration DRFB.5

Configuration: Four inch concrete slab, 1/2" insulation, 2" gravel/rock, 1" sand

#### Testing Conditions:

The specimen had 7/16" plywood bottom, with an R-Value of 0.372.  
This R-Value was subtracted from total product R-Value.

Cold plate temperature: 55°F nominal  
Warm plate temperature: 75°F nominal  
Mean plate temperature: 65.0°F nominal  
Vertical heat flow (Down): Horizontal specimen  
Specimen average thickness: 8.0"  
Specimen average density: 78.75 lbs/ft<sup>3</sup>  
Average thermal resistance (R): 7.54 hr-ft<sup>2</sup>·°F/Btu  
Average thermal resistance (Rsi): 1.33 m<sup>2</sup>·K/W

[www.insulationsolutions.com](http://www.insulationsolutions.com)



# INSUL-TARP®

## Lab Test Evaluation 1

### Insul-Tarp® Lab Test Evaluation 1 Insul-Tarp® vs. Bubble-Foil-Bubble vs. No Insulation

#### Description

Three tests were conducted to evaluate the effectiveness of **Insul-Tarp®** versus another product called Bubble-foil-bubble and also against no insulation. The test consists of a large plastic container 18" deep x 18" wide and 36" long (See figure 1). Temperature thermocouples were inserted into the limestone just beneath the slab and one near the outer surface of the bottom of the container. Continuous heat was applied to the top of the slab while readings from the thermocouples were taken over a period of time. The results of this test are shown in Figure 2. The graph shows the difference in temperature between the upper and lower thermocouple. As you can see after approximately 12 hours, the temperature difference stabilized with the **Insul-Tarp®** with approximately a 150% increase in the differential as compared to the "No Insulation" test.

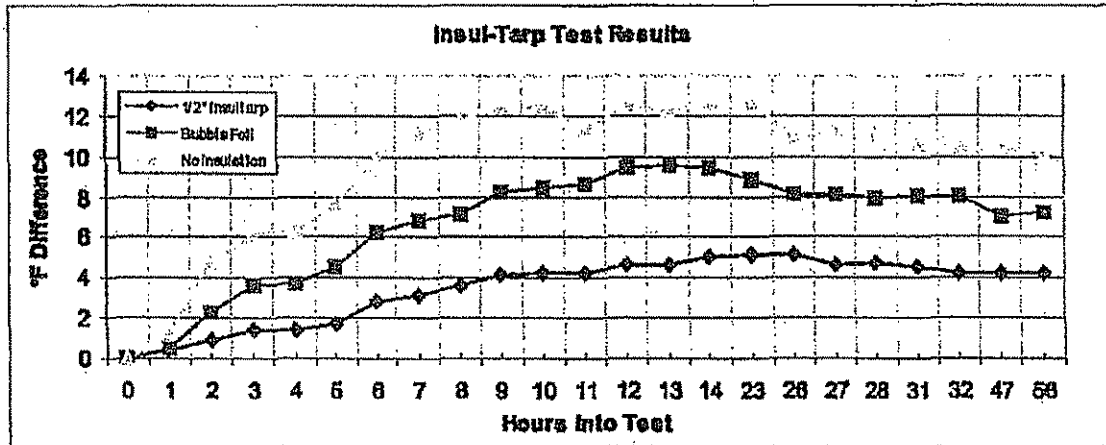

#### Lab Test Results

TEST	Avg. °F Difference *	Temp. Differential Increase
Insul-Tarp Insulation	4.580	0%
Bubble-Foil-Bubble	8.430	84%
No insulation	11.380	148%

\* After Stabilization

#### Conclusions:

Because temperature differential has a linear relationship with heat loss, it is easy to see how the low differential temperature in the 8" of limestone beneath the slab and the **Insul-Tarp®** helps reduce heat loss through the slab to the limestone bedding below. The bubble-foil has a temperature differential nearly twice that of the **Insul-Tarp®** and the No Insulation test has a factor of 2.5 times the differential indicating a significantly larger heat loss characteristic than that of **Insul-Tarp®**.





# INSUL-TARP®

## Lab Test Evaluation 3

### Insul-Tarp® Lab Test Evaluation 3 Insul-Tarp® vs. Bubble-Foil-Bubble vs. 2" Foam Board R-10

#### Description

Three tests were conducted to evaluate the effectiveness of Insul-Tarp® vs. 2 other insulation materials, 3/8" Bubble-Foil-Bubble insulation and 2" Foam Board insulation. The tests were conducted using (3) 11" x 13" test boxes. The test boxes were built using ceramic tile (3/8"), sand, insulation and Raytec-Heat Blanket. Each test box was started at approximately 80° F, then allowed to operate for 60 minutes. The temperature thermocouple was located directly on the ceramic tile surface, measuring the actual surface temperature of the floor material.

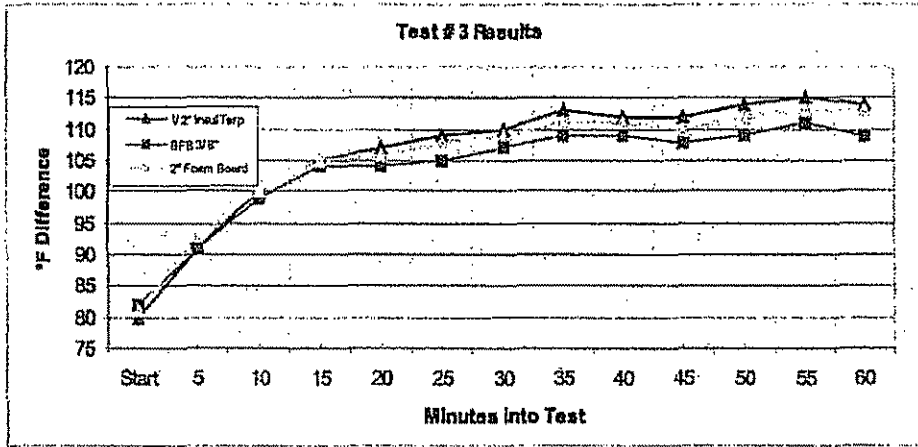

#### Lab Test Results

TEST	Avg. °F Surface Temp. *	Advantage of Insul-tarp vs. Foam Board
Insul-Tarp Insulation	112.86	61.9% Warmer when comparing both to Bubble-Foil-Bubble
Bubble-Foil-Bubble	108.36	
2" Foam Board	111.14	

\* After 30 minutes stabilization period.

#### Conclusions:

Upon stabilization of the test box (~30 minutes) the Insul-Tarp® insulation blanket provides a warmer surface temperature than either the bubble-foil-bubble or the 2" Foam Board. This will increase comfort of the space as well as reduce energy costs. When comparing the surface temperature of the Insul-Tarp® to the Foam Board against the Bubble-Foil-Bubble temperature, Insul-Tarp® insulation provides a 61.9% warmer surface temperature than Foam Board.



# INSUL-TARP®

Lab Test Evaluation 3

Insul-Tarp® Lab Test Evaluation 3  
Insul-Tarp® vs. Bubble-Foil-Bubble vs. 2" Foam Board

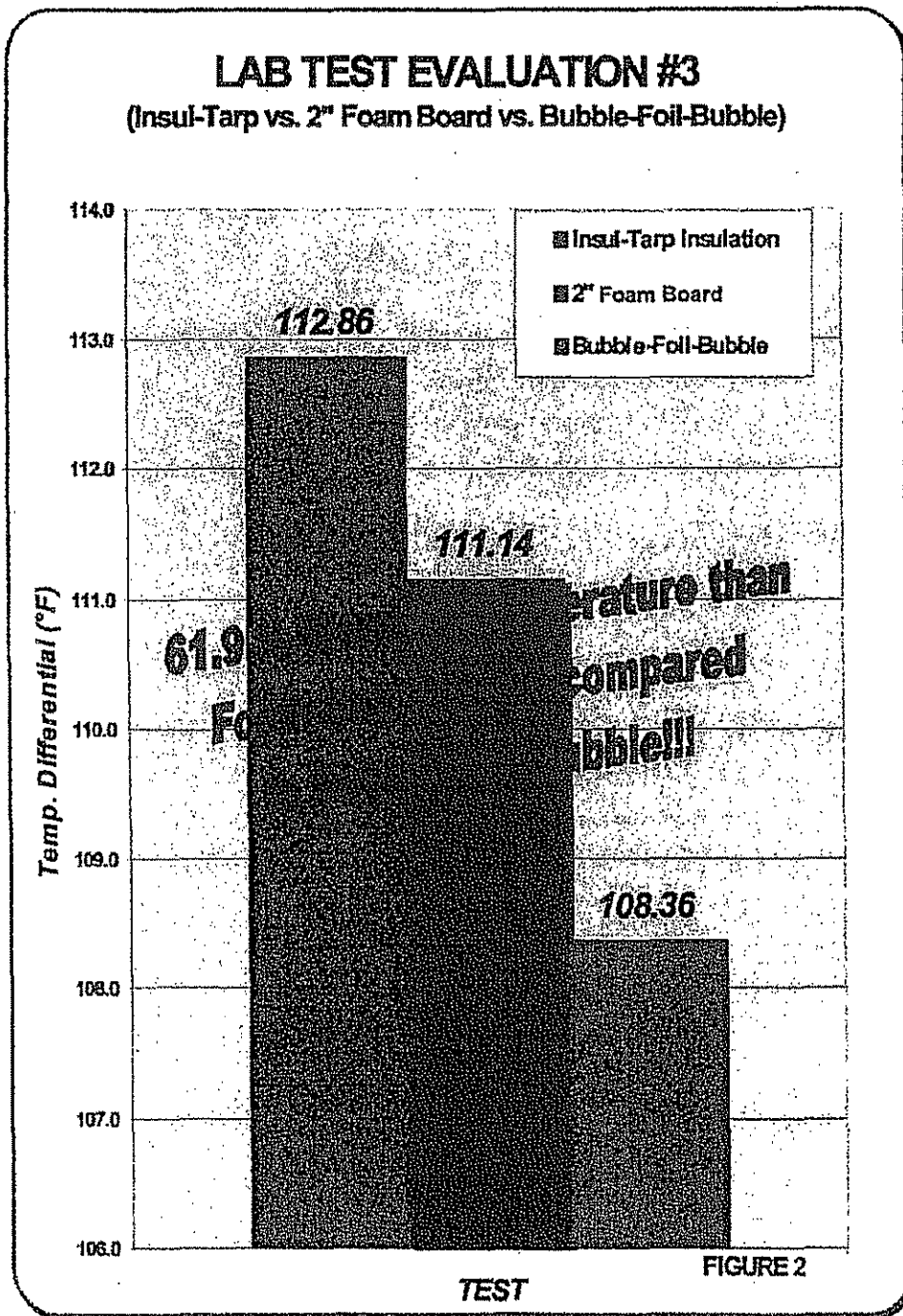



P.O. Box 4051  
Buena Vista, CO 81211

November 5, 2001

RE: Testimony on Insul-Tarp verses 2" Foam Board

Traditionally our heat systems have been installed over 2" foam board insulation. A typical wintertime start up would take 2-3 days to bring the house up to temperature.

In January of 2000 we did our first system with Insul-Tarp. We used it in a 2500 square foot log home on Tennessee Pass in Colorado. The house is located at about 11,500 in elevation.

The day we started the system up was during one of the colder weeks of that year, high temperatures were probably 25-30 degrees and night time lows were probably -10 to -15 degrees, not including wind chill. By the time we filled the system and fired it off, it was about 2:00p.m. After making sure the system was operating properly we left the job site about 3:30 p.m. Upon returning to the job site the next morning about 8:30 a.m. we found that during the evening sometime the system had come up to temperature and satisfied the thermostat which was set at 75 degrees.

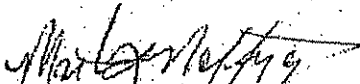
  
Martin L. Naffziger

## **Hi Valley Supply**

2045 W. Amherst  
Englewood, CO 80110  
303-762-9614  
303-762-0588 fax

Don Meyer  
Meyer Enterprises, L.L.C.  
456 W. Camp Street  
East Peoria, IL 61611

Dear Don,

Our company has been on the cutting edge of technology in the field of radiant floor heating. We always strive to provide our customers with the best available products. When we find a new product we like to test it out, whether it is a boiler, side-arm tank, control system, tubing or insulation. We do many projects a year, and our customers have tried out many products. Insul-tarp was one of these products tested by us.

Before using Insul-tarp we were promoting the use for 2" foundation approved polystyrene. We had promoted the use of this product for years, and have several hundred applications installed with this product. Most of our contractors left it up to the general contractor to install the insulation.

Since the introduction of the 1/2" Insul-tarp to our customers, many of, which were skeptical, yet wanted to try this new product or let their general contractors try this product. The results were amazing, the time it took to install insulation under a slab was greatly reduced, the grade of the project did not have to be perfectly flat, the project did not have to be excavated the extra 1-1/2", and the ease of installation. The absolutely incredible part of Insul-tarp, was the performance we have seen during heat up times of the slab. Projects that were done with 2" polystyrene seem to take up to 30% longer to get up to temperature. We have projects in which Insul-tarp was installed, and during the initial fire up of the system, these slabs came up to temperature in record times during some of the coldest months of the year in the Colorado Mountains.

Our customers that have tried the Insul-tarp product know that it works. This product performs better than any other product we have tried. We look forward to the continued use of this product as one of our primary lines in radiant heating. Thank you for providing a product that does what it is supposed to do.

Sincerely,

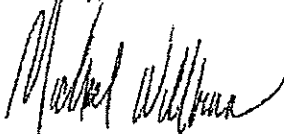

Michael E. Willburn  
Sales & Technical Support





# plumbing supply co.

DISTRIBUTING KITCHEN, BATH & HEATING SUPPLIES

www.activeplumbing.com

**PAINESVILLE...MAIN OFFICE**  
218 RICHMOND STREET  
PAINESVILLE, OHIO 44077  
PHONE (440) 352-4411  
FAX (440) 352-0096

**CLEVELAND**  
239 BROOKPARK ROAD  
CLEVELAND, OHIO 44109  
PHONE (216) 459-2700  
FAX (216) 459-0268

**WILLOUGHBY**  
38033 ELM STREET  
WILLOUGHBY, OHIO 44094  
PHONE (440) 953-1532  
FAX (440) 953-0649

**BAINBRIDGE**  
9890 E. WASHINGTON STREET  
BAINBRIDGE, OHIO 44023  
PHONE (440) 543-2233  
FAX (440) 543-7905

**ASHTABULA**  
1220 LAKE AVENUE  
ASHTABULA, OHIO 44004  
PHONE (440) 964-7575  
FAX (440) 964-7449

October 20, 2004

Attn: Donald L. Meyer, President/CEO

Re: Testimony on Insul-Tarp versus 2" foam board

Traditionally our heating systems have been installed over 1" or 2" foam board. A typical wintertime start up would take 2-3 days to bring the house up to temperature.

In February 2002, we did our first system with Insul-Tarp. My Customer used 1800 square feet for an office building at a nursery located on Lake Erie, in Lake County, Ohio.

My customer was very worried about the new Insul-Tarp, since winds off of the lake have a wind chill factor of -15 to -20 degrees. We also used an instantaneous water heater with pex pipe for the slab. My customer filled the system and started it up at 5:30 pm when leaving the job. At 8:30 am the next day when he returned, he found the office building temperature 70 degrees and the system had shut down. My customer called me at once to let me know that he did not need the 2 to 3 days running time. Insul-Tarp made the difference.

Sincerely,

Clay Curtis  
Heating Dept.  
Active Plumbing Supply

CC/lms

## What You Should Know About R-Values

R means resistance to heat flow, the higher the R-value, the greater the insulating power. Compare insulation R-values before you buy. Actual R-values in field applications may vary depending upon usage and conditions. There are other factors to consider. The amount of insulation you need depends mainly on the climate you live in. Also, your fuel savings from insulation will depend upon the climate, the type and size of your building, the amount of insulation already in your building, and your fuel use patterns. If you buy too much insulation, it will cost you more than what you will save on fuel. To get the marked R-value, it is essential that the insulation be installed properly. Copies of installation and test data are available upon request for Insulation Solutions' products.

### Product Performance

The Federal Trade Commission R-value Rule covers reflective insulation and radiant barrier products. The rule requires that industry members use specific test procedures for measuring the R-value of reflective insulations with single and multiple reflective surfaces. Standard R-value testing is not appropriate for radiant barrier products used under concrete slabs, because generally no accepted test procedure exists to determine the full R-value of the product. Sellers who make energy saving claims for radiant barrier insulation must have a reasonable basis for the claims according to the FTC.

Most insulation is rated in R-value. Usually R-value can be easily checked with testing because it simply measures the travel of heat over time through a given thickness of material, which has a thermal resistance. Aluminum restricts heat flow in a very different manner than conventional insulations and its performance is application specific. Tests are then done on an outcome and comparative basis in order to evaluate the thermal resistance of a given material. Slab assemblies have been tested side by side with conventional insulation, no insulation, and with "Insul-Tarp®."

By comparing the results, a relative or equivalent R-value can be assigned for the insulation, for that application and configuration, based on how it performs under the same conditions.

The following tests have been performed and results have been examined and evaluated by Clark Engineering, which is a consulting engineering firm involved in the design of building heating, ventilation, and air-conditioning systems. Clark Engineering has found "Insul-Tarp®" to have proven itself through numerous tests, case studies, and evaluations to be an exceptional product, and out performs similar materials based on the testing and information in the Insul-Tarp® Catalog.

A full Insul-Tarp® Catalog can be attained by calling 1-866-698-0062 or by writing to [info@insulationsolutions.com](mailto:info@insulationsolutions.com).